

# GRUNER BRASS FITTINGS CORP.

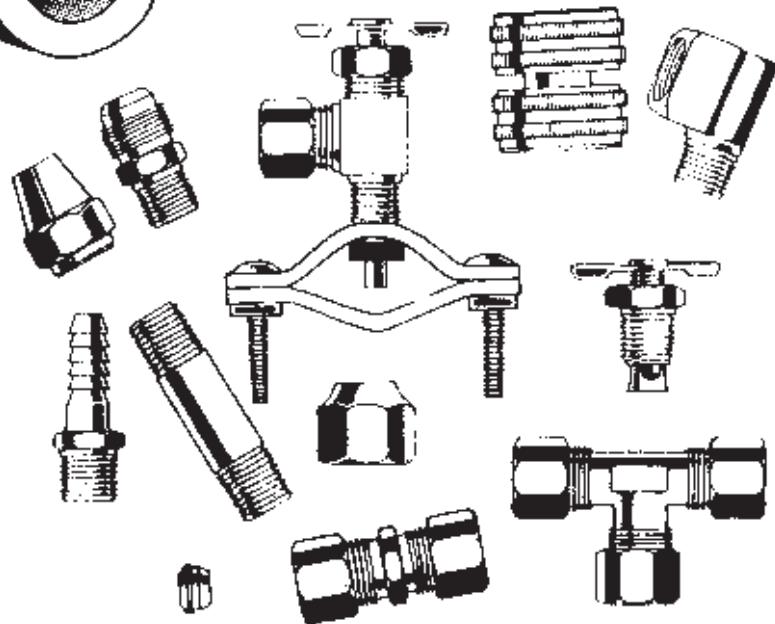

---

## **GRUNER BRASS FITTINGS CORP.**

173 Glenmore Avenue, Brooklyn, NY 11212

Tel. (718) 495-5820 • Fax (718) 495-5824

info@grunerbrass.com • www.grunerbrass.com

## THREAD SPECIFICATIONS

### TUBE FITTINGS

TYPE FITTING	O. D. TUBE SIZE										
	1/8	3/16	1/4	5/16	3/8	7/16	1/2	5/8	3/4	7/8	1
45° Flare	5/16x24	3/8x24	7/16x20	1/2x20	5/8x18	11/16x16	3/4x16	7/8x14	1-1/16x14	1-1/4x12	1-3/8x12
Compression/A-Lign	5/16x24	3/8x24	7/16x24	1/2x24	9/16x24	5/8x24	11/16x20	13/16x18	1x18	1-1/8x18	
Inverted Flare	5/16x28	3/8x24	7/16x24	1/2x20	5/8x18	11/16x18	3/4x18	7/8x18	1-1/16x16		
Double Compression	5/16x24	3/8x24	7/16x24	1/2x20	9/16x20	5/8x18	11/16x16	7/8x18			
Poly-Fit	5/16x24	3/8x24	3/8x24	7/16x24	1/2x24		11/16x20				
Air Brake			7/16x24		17/32x24		11/16x20	13/16x18	1x18		
Pipe	1/8x27		1/4x18		3/8x18		1/2x14		3/4x14		1x11-1/2

## MATERIAL COMPOSITION

## MATERIAL COMPOSITION

### Material used for Brass Fittings

**Straight bodies:** Barstock CA 360 or CA 345  
**Shape bodies:** Extruded barstock CA 360 or Forged CA 377  
**Nuts:** Barstock CA 360 or Forged CA 377

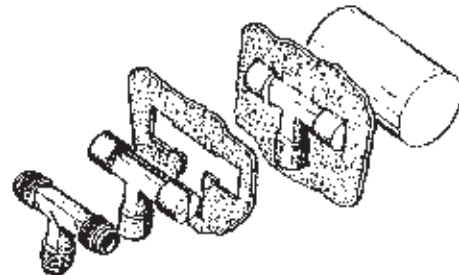
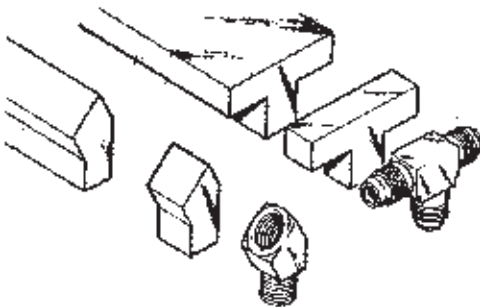

#### Extruded Barstock Fittings

Hexagon, round and shaped bars are extruded in the configuration required, drawn to size, cut to length and straightened. First a solid round billet (8 to 12 inches in diameter) is heated to the pliable state and forced by pressure of approximately 80,000 pounds per square inch through a die. The resulting continuous length of bar is cooled and then drawn through dies to the desired external size. ( The drawing process also controls the temper. ) After straightening, the bar is ready for machining.

The process produces a dense, nonporous material somewhat stronger in the longitudinal direction due to an orientated flow of the grain.

#### Forged Fittings

Material for forging is extruded in round bars, cut to length and straightened. (At this point in the process, forging rod differs from round extruded machinable bars only in temper and chemical properties. ) After straightening, the bars are cut again into slugs (short lengths), reheated to the pliable state and pressed under a pressure of approximately 25,000 pounds per square inch between upper and lower die cavities. After cooling the flash is trimmed away and the forging blank is ready for machining.

This process of forming under extreme pressure produces a uniformly dense material of exceptional strength. Because grain flow follows the contour, the fitting has high impact strength and is resistant to mechanical shock and vibration.

# TABLE OF CONTENTS

Compression Fittings . . . . .	2
Compression Fittings, Chrome Plated . . . . .	6
45° Flare Fittings . . . . .	7
Inverted Flare Fittings . . . . .	11
Threaded Sleeve Fittings . . . . .	12
Refrigeration 45° Flare Fittings . . . . .	13
Brass Pipe Fittings . . . . .	21
Hose Barb Fittings . . . . .	25
Garden Hose Fittings . . . . .	27
Forged Brass PEX Fittings . . . . .	29
Gas Stove Adapters . . . . .	31
Aluminum Tubing . . . . .	31
Air Valve Coin/Key . . . . .	31
Duplex Bushings . . . . .	31
POL Fittings . . . . .	32
Brass Lavatory Supplies . . . . .	32
Needle Valves . . . . .	33
Icemaker Kits . . . . .	33
Draincocks/Ground Plug Shut-off . . . . .	34
Oil Tank Valves . . . . .	34
125 lb. Threaded Brass Fittings . . . . .	35

# COMPRESSION FITTINGS

## SLEEVE 60

PART NO.	TUBE SIZE
60-2	1/8
60-3	3/16
60-4	1/4
60-5	5/16
60-6	3/8
60-7	7/16
60-8	1/2
60-10	5/8
60-12	3/4
60-14	7/8



## DELTRIN SLEEVE 60PT

PART NO.	PLASTIC TUBE O.D.	TUBE WALL
60PT-4	1/4	.040
60PT-5	5/16	.062
60PT-6	3/8	.062
60PT-8	1/2	.062
60PT-10	5/8	.062
60PT-12	3/4	.062



## NUT 61

PART NO.	TUBE SIZE	STRAIGHT THREAD
61-2	1/8	5/16-24
61-3	3/16	3/8-24
61-4	1/4	7/16-24
61-5	5/16	1/2-24
61-6	3/8	9/16-24
61-7	7/16	5/8-24
61-8	1/2	11/16-20
61-10	5/8	13/16-18
61-12	3/4	1-18
61-14	7/8	1-1/8-18



## LONG NUT 61L

PART NO.	TUBE SIZE	STRAIGHT THREAD
61L-4	1/4	7/16-24
61L-5	5/16	1/2-24
61L-6	3/8	9/16-24
61L-8	1/2	11/16-20
61L-10	5/8	13/16-18
61L-12	3/4	1-18



## SOLID CAP 61S

PART NO.	TUBE SIZE	STRAIGHT THREAD
61S-3	3/16	3/8-24
61S-4	1/4	7/16-24
61S-5	5/16	1/2-24
61S-6	3/8	9/16-24
61S-8	1/2	11/16-20
61S-10	5/8	13/16-18



## NUT AND SLEEVE ASSEMBLY 61CA

PART NO.	TUBE SIZE	STRAIGHT THREAD
61CA-2	1/8	5/16-24
61CA-3	3/16	3/8-24
61CA-4	1/4	7/16-24
61CA-5	5/16	1/2-24
61CA-6	3/8	9/16-24
61CA-8	1/2	11/16-20
61CA-10	5/8	13/16-18



## UNION 62

PART NO.	TUBE SIZE	STRAIGHT THREAD
62-2	1/8	5/16-24
62-3	3/16	3/8-24
62-4	1/4	7/16-24
62-5	5/16	1/2-24
62-6	3/8	9/16-24
62-7	7/16	5/8-24
62-8	1/2	11/16-20
62-10	5/8	13/16-18
62-12	3/4	1-18
62-14	7/8	1 1/8-18



## UNION REDUCERS 62

PART NO.	1 TUBE SIZE	2 TUBE SIZE	1 STRAIGHT THREAD	2 STRAIGHT THREAD
62-4-2	1/4	1/8	7/16-24	5/16-24
62-4-3	1/4	3/16	7/16-24	3/8-24
62-5-4	5/16	1/4	1/2-24	7/16-24
62-6-4	3/8	1/4	9/16-24	7/16-24
62-6-5	3/8	5/16	9/16-24	1/2-24
62-8-6	1/2	3/8	11/16-20	9/16-24
62-10-6	5/8	3/8	13/16-18	9/16-24
62-10-8	5/8	1/2	13/16-18	11/16-20

# COMPRESSION FITTINGS

## BULKHEAD UNION 62BH

PART NO.	TUBE SIZE	STRAIGHT THREAD
62BH-4	1/4	7/16-24
62BH-6	3/8	9/16-24



## MALE CONNECTOR 68

PART NO.	TUBE SIZE	PIPE THREAD	STRAIGHT THREAD
68-2-2	1/8	1/8	5/16-24
68-3-2	3/16	1/8	3/8-24
68-3-4	3/16	1/4	3/8-24
68-4-2	1/4	1/8	7/16-24
68-4-4	1/4	1/4	7/16-24
68-4-6	1/4	3/8	7/16-24
68-4-8	1/4	1/2	7/16-24
68-5-2	5/16	1/8	1/2-24
68-5-4	5/16	1/4	1/2-24
68-5-6	5/16	3/8	1/2-24
68-5-8	5/16	1/2	1/2-24
68-6-2	3/8	1/8	9/16-24
68-6-4	3/8	1/4	9/16-24
68-6-6	3/8	3/8	9/16-24
68-6-8	3/8	1/2	9/16-24
68-6-12	3/8	3/4	9/16-24
68-7-4	7/16	1/4	5/8-24
68-7-6	7/16	3/8	5/8-24
68-8-4	1/2	1/4	11/16-20
68-8-6	1/2	3/8	11/16-20
68-8-8	1/2	1/2	11/16-20
68-8-12	1/2	3/4	11/16-20
68-10-6	5/8	3/8	13/16-18
68-10-8	5/8	1/2	13/16-18
68-10-12	5/8	3/4	13/16-18
68-12-8	3/4	1/2	1-18
68-12-12	3/4	3/4	1-18
68-14-8	7/8	1/2	1 1/8-18
68-14-12	7/8	3/4	1 1/8-18
68-14-16	7/8	1	1 1/8-18

## BRASS INSERT 63PT

PART NO.	TUBE O.D.	TUBE WALL
63PT-2	1/8	.016
63PT-3	3/16	.025
63PT-4	1/4	.040
63PT-5	5/16	.062
63PT-6	3/8	.062
63PT-8	1/2	.062
63PT-10	5/8	.062

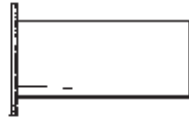

For plastic tubing

Delrin Sleeve 60PT and Brass Insert 63PT converts standard compression fittings for use with industrial grades of thermo-plastic tubing.

## FEMALE CONNECTOR 66

PART NO.	TUBE SIZE	PIPE THREAD	STRAIGHT THREAD
66-2-2	1/8	1/8	5/16-24
66-3-2	3/16	1/8	3/8-24
66-3-4	3/16	1/4	3/8-24
66-4-2	1/4	1/8	7/16-24
66-4-4	1/4	1/4	7/16-24
66-4-6	1/4	3/8	7/16-24
66-4-8	1/4	1/2	7/16-24
66-5-2	5/16	1/8	1/2-24
66-5-4	5/16	1/4	1/2-24
66-5-6	5/16	3/8	1/2-24
66-6-2	3/8	1/8	9/16-24
66-6-4	3/8	1/4	9/16-24
66-6-6	3/8	3/8	9/16-24
66-6-8	3/8	1/2	9/16-24
66-6-12	3/8	3/4	9/16-24
66-8-4	1/2	1/4	11/16-20
66-8-6	1/2	3/8	11/16-20
66-8-8	1/2	1/2	11/16-20
66-10-6	5/8	3/8	13/16-18
66-10-8	5/8	1/2	13/16-18
66-10-12	5/8	3/4	13/16-18
66-12-8	3/4	1/2	1-18
66-12-12	3/4	3/4	1-18
66-14-12	7/8	3/4	1 1/8-18



## SWEAT ADAPTOR 668

Tube To SolderN

TUBE SIZE	SOLDER SIZE
3/8	1/2

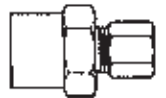

## ELBOW 670

Tube To Solder

TUBE SIZE	SOLDER SIZE
3/8	1/2



## SEAL PLUG 639

PART NO.	TUBE SIZE	STRAIGHT THREAD
639-4	1/4	7/16-24



# COMPRESSION FITTINGS

## UNION TEE 64

PART NO.	TUBE SIZE	STRAIGHT THREAD
64-2	1/8	5/16-24
64-3	3/16	3/8-24
64-4	1/4	7/16-24
64-5	5/16	1/2-24
64-6	3/8	9/16-24
64-8	1/2	11/16-20
64-10	5/8	13/16-18
64-12	3/4	1-18
64-14	7/8	1 1/8-18

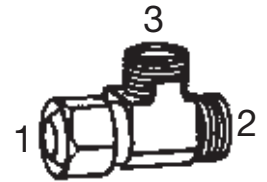
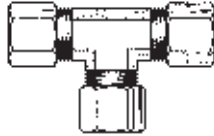

## MAX TEE TS64

PART NO.	1 TUBE SIZE	2 TUBE SIZE	3 TUBE SIZE
TS-64-4	3/8	3/8	1/4
TS-64-6	3/8	3/8	3/8

## UNION TEE 64

Combination sizes

PART NO.	1&2 TUBE SIZE	3 TUBE SIZE
64-4-2	1/4	1/8
64-4-3	1/4	3/16
64-6-4	3/8	1/4
64-8-4	1/2	1/4
64-8-6	1/2	3/8
64-10-6	5/8	3/8
64-10-8	5/8	1/2

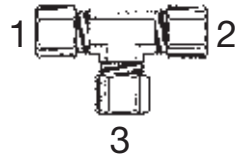

## MALE ELBOW 69

PART NO.	TUBE SIZE	PIPE THREAD	STRAIGHT THREAD
69-2-2	1/8	1/8	5/16-24
69-3-2	3/16	1/8	3/8-24
69-3-4	3/16	1/4	3/8-24
69-4-2	1/4	1/8	7/16-24
69-4-4	1/4	1/4	7/16-24
69-4-6	1/4	3/8	7/16-24
69-4-8	1/4	1/2	7/16-24
69-5-2	5/16	1/8	1/2-24
69-5-4	5/16	1/4	1/2-24
69-5-6	5/16	3/8	1/2-24
69-6-2	3/8	1/8	9/16-24
69-6-4	3/8	1/4	9/16-24
69-6-6	3/8	3/8	9/16-24
69-6-8	3/8	1/2	9/16-24
69-6-12	3/8	3/4	9/16-24
69-7-4	7/16	1/4	5/8-24
69-7-6	7/16	3/8	5/8-24
69-8-4	1/2	1/4	11/16-20
69-8-6	1/2	3/8	11/16-20
69-8-8	1/2	1/2	11/16-20
69-8-12	1/2	3/4	11/16-20
69-10-6	5/8	3/8	13/16-18
69-10-8	5/8	1/2	13/16-18
69-10-12	5/8	3/4	13/16-18
69-12-8	3/4	1/2	1-18
69-12-12	3/4	3/4	1-18
69-14-8	7/8	1/2	1 1/8-18
69-14-12	7/8	3/4	1 1/8-18

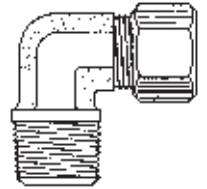

## UNION ELBOW 65

PART NO.	TUBE SIZE	STRAIGHT THREAD
65-2	1/8	5/16-24
65-3	3/16	3/8-24
65-4	1/4	7/16-24
65-5	5/16	1/2-24
65-6	3/8	9/16-24
65-7	7/16	5/8-24
65-8	1/2	11/16-20
65-10	5/8	13/16-18
65-12	3/4	1-18
65-14	7/8	1 1/8-18

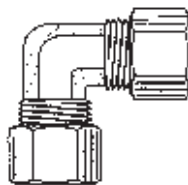
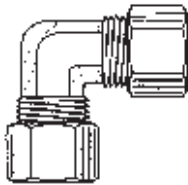

## UNION ELBOW 65

Combination sizes

PART NO.	1 TUBE SIZE	2 TUBE SIZE	1 STRAIGHT THREAD	2 STRAIGHT THREAD
65-6-4	3/8	1/4	9/16-24	7/16-24
65-8-6	1/2	3/8	11/16-20	9/16-24
65-10-6	5/8	3/8	13/16-18	9/16-24
65-10-8	5/8	1/2	13/16-18	11/16-20

# COMPRESSION FITTINGS

## FEMALE ELBOW 70

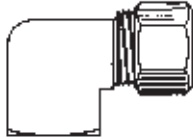

PART NO.	TUBE SIZE	PIPE THREAD	STRAIGHT THREAD
70-2-2	1/8	1/8	5/16-24
70-3-2	3/16	1/8	3/8-24
70-4-2	1/4	1/8	7/16-24
70-4-4	1/4	1/4	7/16-24
70-4-6	1/4	3/8	7/16-24
70-5-2	5/16	1/8	1/2-24
70-5-4	5/16	1/4	1/2-24
70-6-2	3/8	1/8	9/16-24
70-6-4	3/8	1/4	9/16-24
70-6-6	3/8	3/8	9/16-24
70-6-8	3/8	1/2	9/16-24
70-8-4	1/2	1/4	11/16-20
70-8-6	1/2	3/8	11/16-20
70-8-8	1/2	1/2	11/16-20
70-8-12	1/2	3/4	11/16-20
70-10-6	5/8	3/8	13/16-18
70-10-8	5/8	1/2	13/16-18
70-10-12	5/8	3/4	13/16-18
70-12-8	3/4	1/2	1-18
70-12-12	3/4	3/4	1-18

## MALE BRANCH TEE 72

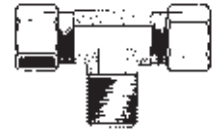

PART NO.	TUBE SIZE	PIPE THREAD	STRAIGHT THREAD
72-2-2	1/8	1/8	5/16-24
72-3-2	3/16	1/8	3/8-24
72-4-2	1/4	1/8	7/16-24
72-4-4	1/4	1/4	7/16-24
72-6-2	3/8	1/8	9/16-24
72-6-4	3/8	1/4	9/16-24
72-6-6	3/8	3/8	9/16-24
72-8-6	1/2	3/8	11/16-20
72-8-8	1/2	1/2	11/16-20
72-10-8	5/8	1/2	13/16-18
72-12-8	3/4	1/2	1-18
72-12-12	3/4	3/4	1-18

## ADAPTER TEE 76



PART NO.	TUBE SIZE	PIPE THREAD	STRAIGHT THREAD
76-4-2	1/4	1/8	7/16-24

## MALE RUN TEE 71

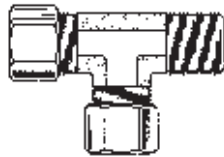

PART NO.	TUBE SIZE	PIPE THREAD	STRAIGHT THREAD
71-2-2	1/8	1/8	5/16-24
71-3-2	3/16	1/8	3/8-24
71-4-2	1/4	1/8	7/16-24
71-4-4	1/4	1/4	7/16-24
71-5-2	5/16	1/8	1/2-24
71-5-4	5/16	1/4	1/2-24
71-6-2	3/8	1/8	9/16-24
71-6-4	3/8	1/4	9/16-24
71-6-6	3/8	3/8	9/16-24
71-8-6	1/2	3/8	11/16-20
71-8-8	1/2	1/2	11/16-20
71-10-8	5/8	1/2	13/16-18
71-12-8	3/4	1/2	1-18
71-12-12	3/4	3/4	1-18

## FEMALE BRANCH TEE 72F



PART NO.	TUBE SIZE	PIPE THREAD	STRAIGHT THREAD
72F-4-2	1/4	1/8	7/16-24
72F-4-4	1/4	1/4	7/16-24
72F-6-2	3/8	1/8	9/16-24
72F-6-4	3/8	1/4	9/16-24
72F-6-6	3/8	3/8	9/16-24

## 45° ELBOW 69-45

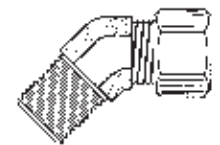

PART NO.	TUBE SIZE	PIPE THREAD	STRAIGHT THREAD
69-45-4-2	1/4	1/8	7/16-24
69-45-4-4	1/4	1/4	7/16-24
69-45-5-2	5/16	1/8	1/2-24
69-45-5-4	5/16	1/4	1/2-24
69-45-6-2	3/8	1/8	9/16-24
69-45-6-4	3/8	1/4	9/16-24
69-45-6-6	3/8	3/8	9/16-24
69-45-8-6	1/2	3/8	11/16-20
69-45-8-8	1/2	1/2	11/16-20
69-45-10-8	5/8	1/2	13/16-18

# CHROME PLATED COMPRESSION FITTINGS

## NUT 61C-8 CHROME

PART NO.	TUBE SIZE	STRAIGHT THREAD
61C-8-4	1/4	7/16-24
61C-8-6	3/8	9/16-24
61C-8-8	1/2	11/16-20
61C-8-10	5/8	13/16-18

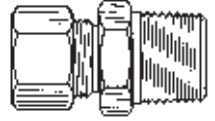

## MALE CONNECTOR 68C-8 CHROME

PART NO.	TUBE SIZE	PIPE THREAD	STRAIGHT THREAD
68C-8-6-6	3/8	3/8	9/16-24
68C-8-6-8	3/8	1/2	9/16-24
68C-8-8-6	1/2	3/8	11/16-20
68C-8-8-8	1/2	1/2	11/16-20

## UNION 62C-8 CHROME

PART NO.	TUBE SIZE	STRAIGHT THREAD
62C-8-4	1/4	7/16-24
62C-8-6	3/8	9/16-24
62C-8-8	1/2	11/16-20
62C-8-10	5/8	13/16-18



## SWEAT ADAPTER 68SC-8 CHROME

*Tube to Solder*

PART NO.	TUBE SIZE	SOLDER SIZE
68SC-8	3/8	1/2



## SWEAT ELBOW 70SC-8 CHROME

*Tube To Solder*

PART NO.	TUBE SIZE	SOLDER SIZE
70SC-8	3/8	1/2



## UNION REDUCERS 62C-8 CHROME

PART NO.	TUBE SIZE	TUBE SIZE	STRAIGHT THREAD	STRAIGHT THREAD
62C-8-6-4	3/8	1/4	9/16-24	7/16-24
62C-8-8-6	1/2	3/8	11/16-20	9/16-24
62C-8-10-6	5/8	3/8	13/16-18	9/16-24
62C-8-10-8	5/8	1/2	13/16-18	11/16-20

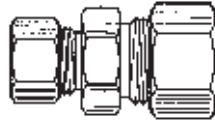

## MALE ELBOW 69C-8 CHROME

PART NO.	TUBE SIZE	PIPE THREAD	STRAIGHT THREAD
69C-8-6-6	3/8	3/8	9/16-24
69C-8-6-8	3/8	1/2	9/16-24
69C-8-8-8	1/2	1/2	11/16-20



## FEMALE CONNECTOR 66C-8 CHROME

PART NO.	TUBE SIZE	PIPE THREAD	STRAIGHT THREAD
66C-8-6-6	3/8	3/8	9/16-24
66C-8-6-8	3/8	1/2	9/16-24
66C-8-8-6	1/2	3/8	11/16-20
66C-8-8-8	1/2	1/2	11/16-20



## FEMALE ELBOW 70C-8 CHROME

PART NO.	TUBE SIZE	PIPE THREAD	STRAIGHT THREAD
70C-8-6-6	3/8	3/8	9/16-24
70C-8-6-8	3/8	1/2	9/16-24





# 45° FLARE FITTINGS

## SHORT NUT 41S

PART NO.	TUBE SIZE	STRAIGHT THREAD
41S-2	1/8	5/16-24
41S-3	3/16	3/8-24
41S-4	1/4	7/16-20
41S-5	5/16	1/2-20
41S-6	3/8	5/8-18
41S-7	7/16	11/16-16
41S-8	1/2	3/4-16
41S-10	5/8	7/8-14
41S-12	3/4	1 1/16-14
41S-14	7/8	1 1/4-12

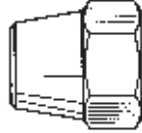

## LONG NUT 41L

PART NO.	TUBE SIZE	STRAIGHT THREAD
41L-2	1/8	5/16-24
41L-3	3/16	3/8-24
41L-4	1/4	7/16-20
41L-5	5/16	1/2-20
41L-6	3/8	5/8-18
41L-8	1/2	3/4-16
41L-10	5/8	7/8-14
41L-12	3/4	1 1/16-14

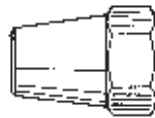

## CAP NUT 56

PART NO.	TUBE SIZE	STRAIGHT THREAD
56-3	3/16	3/8-24
56-4	1/4	7/16-20
56-5	5/16	1/2-20
56-6	3/8	5/8-18
56-8	1/2	3/4-16
56-10	5/8	7/8-14
56-12	3/4	1 1/16-24



## FLARED SEAL PLUG 58

PART NO.	TUBE SIZE	STRAIGHT THREAD
58-4	1/4	7/16-20
58-5	5/16	1/2-20
58-6	3/8	5/8-18
58-8	1/2	3/4-16
58-10	5/8	7/8-14
58-12	3/4	1 1/16-24

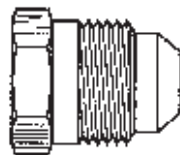

## UNION 42

PART NO.	TUBE SIZE	STRAIGHT THREAD
42-2	1/8	5/16-24
42-3	3/16	3/8-24
42-4	1/4	7/16-20
42-5	5/16	1/2-20
42-6	3/8	5/8-18
42-8	1/2	3/4-16
42-10	5/8	7/8-14
42-12	3/4	1 1/16-14
42-14	7/8	1 1/4-12

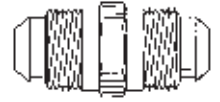

## UNION REDUCERS 42R

PART NO.	TUBE SIZE	TUBE SIZE	STRAIGHT THREAD	STRAIGHT THREAD
42R-4-3	1/4	3/16	7/16-20	3/8-24
42R-5-4	5/16	1/4	1/2-20	7/16-20
42R-6-4	3/8	1/4	5/8-18	7/16-20
42R-6-5	3/8	5/16	5/8-18	1/2-20
42R-8-4	1/2	1/4	3/4-16	7/16-20
42R-8-6	1/2	3/8	3/4-16	5/8-18
42R-10-6	5/8	3/8	7/8-14	5/8-18
42R-10-8	5/8	1/2	7/8-14	3/4-16
42R-12-8	3/4	1/2	1 1/16-14	3/4-16
42R-12-10	3/4	5/8	1 1/16-14	7/8-14

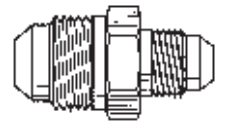

## CROSS 455

PART NO.	TUBE SIZE	STRAIGHT THREAD
455-4	1/4	7/16-20
455-6	3/8	5/8-18
455-8	1/2	3/4-16
455-10	5/8	7/8-14

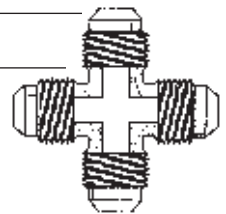

## UNION TEE 44

PART NO.	TUBE SIZE	STRAIGHT THREAD
44-2	1/8	5/16-24
44-3	3/16	3/8-24
44-4	1/4	7/16-20
44-5	5/16	1/2-20
44-6	3/8	5/8-18
44-8	1/2	3/4-16
44-10	5/8	7/8-14
44-12	3/4	1 1/16-14
44-14	7/8	1 1/4-12

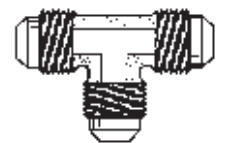

# 45° FLARE FITTINGS

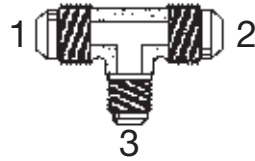

## UNION TEE 44R

Combination sizes

PART NO.	1 TUBE SIZE	2 TUBE SIZE	3 TUBE SIZE
44R-4-4-6	1/4	1/4	3/8
44R-4-4-8	1/4	1/4	1/2
44R-6-4-4	3/8	1/4	1/4
44R-6-4-6	3/8	1/4	3/8
44R-6-6-4	3/8	3/8	1/4
44R-6-6-8	3/8	3/8	1/2
44R-6-6-10	3/8	3/8	5/8
44R-8-6-6	1/2	3/8	3/8
44R-8-6-8	1/2	3/8	1/2
44R-8-8-4	1/2	1/2	1/4
44R-8-8-6	1/2	1/2	3/8
44R-8-8-10	1/2	1/2	5/8
44R-10-8-8	5/8	1/2	1/2
44R-10-8-10	5/8	1/2	5/8
44R-10-10-6	5/8	5/8	3/8
44R-10-10-8	5/8	5/8	1/2
44R-12-12-8	3/4	3/4	1/2

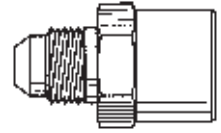

## FEMALE CONNECTOR 46

PART NO.	TUBE SIZE	PIPE THREAD	STRAIGHT THREAD
46-2-2	1/8	1/8	5/16-24
46-3-2	3/16	1/8	3/8-24
46-4-2	1/4	1/8	7/16-20
46-4-4	1/4	1/4	7/16-20
46-4-6	1/4	3/8	7/16-20
46-4-8	1/4	1/2	7/16-20
46-5-2	5/16	1/8	1/2-20
46-5-4	5/16	1/4	1/2-20
46-5-6	5/16	3/8	1/2-20
46-6-2	3/8	1/8	5/8-18
46-6-4	3/8	1/4	5/8-18
46-6-6	3/8	3/8	5/8-18
46-6-8	3/8	1/2	5/8-18
46-6-12	3/8	3/4	5/8-18
46-8-4	1/2	1/4	3/4-16
46-8-6	1/2	3/8	3/4-16
46-8-8	1/2	1/2	3/4-16
46-8-12	1/2	3/4	3/4-16
46-10-6	5/8	3/8	7/8-14
46-10-8	5/8	1/2	7/8-14
46-10-12	5/8	3/4	7/8-14
46-12-8	3/4	1/2	1 1/16-14
46-12-12	3/4	3/4	1 1/16-14
46-14-12	7/8	3/4	1 1/4-12

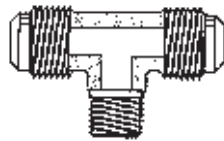

## MALE BRANCH TEE 45

PART NO.	TUBE SIZE	PIPE THREAD	STRAIGHT THREAD
45-2-2	1/8	1/8	5/16-24
45-3-2	3/16	1/8	3/8-24
45-4-2	1/4	1/8	7/16-20
45-4-4	1/4	1/4	7/16-20
45-4-6	1/4	3/8	7/16-20
45-4-8	1/4	1/2	7/16-20
45-5-2	5/16	1/8	1/2-20
45-5-4	5/16	1/4	1/2-20
45-6-2	3/8	1/8	5/8-18
45-6-4	3/8	1/4	5/8-18
45-6-6	3/8	3/8	5/8-18
45-6-8	3/8	1/2	5/8-18
45-8-4	1/2	1/4	3/4-16
45-8-6	1/2	3/8	3/4-16
45-8-8	1/2	1/2	3/4-16
45-10-6	5/8	3/8	7/8-14
45-10-8	5/8	1/2	7/8-14
45-12-8	3/4	1/2	1 1/16-14
45-12-12	3/4	3/4	1 1/16-14

# 45° FLARE FITTINGS

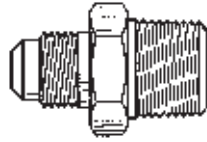

## MALE CONNECTOR 48

PART NO.	TUBE SIZE	PIPE THREAD	STRAIGHT THREAD
48-2-2	1/8	1/8	5/16-24
48-3-2	3/16	1/8	3/8-24
48-3-4	3/16	1/4	3/8-24
48-4-2	1/4	1/8	7/16-20
48-4-4	1/4	1/4	7/16-20
48-4-6	1/4	3/8	7/16-20
48-4-8	1/4	1/2	7/16-20
48-5-2	5/16	1/8	1/2-20
48-5-4	5/16	1/4	1/2-20
48-5-6	5/16	3/8	1/2-20
48-6-2	3/8	1/8	5/8-18
48-6-4	3/8	1/4	5/8-18
48-6-6	3/8	3/8	5/8-18
48-6-8	3/8	1/2	5/8-18
48-6-12	3/8	3/4	5/8-18
48-8-2	1/2	1/8	3/4-16
48-8-4	1/2	1/4	3/4-16
48-8-6	1/2	3/8	3/4-16
48-8-8	1/2	1/2	3/4-16
48-8-12	1/2	3/4	3/4-16
48-10-4	5/8	1/4	7/8-14
48-10-6	5/8	3/8	7/8-14
48-10-8	5/8	1/2	7/8-14
48-10-12	5/8	3/4	7/8-14
48-12-6	3/4	3/8	1 1/16-14
48-12-8	3/4	1/2	1 1/16-14
48-12-12	3/4	3/4	1 1/16-14
48-14-8	7/8	1/2	1 1/4-12
48-14-12	7/8	3/4	1 1/4-12
48-16-12	1	3/4	1-11-1/2

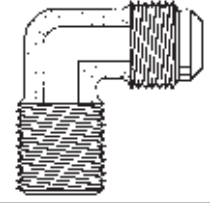

## MALE ELBOW 49

PART NO.	TUBE SIZE	PIPE THREAD	STRAIGHT THREAD
49-2-2	1/8	1/8	5/16-24
49-3-2	3/16	1/8	3/8-24
49-3-4	3/16	1/4	3/8-24
49-4-2	1/4	1/8	7/16-20
49-4-4	1/4	1/4	7/16-20
49-4-6	1/4	3/8	7/16-20
49-4-8	1/4	1/2	7/16-20
49-5-2	5/16	1/8	1/2-20
49-5-4	5/16	1/4	1/2-20
49-5-6	5/16	3/8	1/2-20
49-5-8	5/16	1/2	1/2-20
49-6-2	3/8	1/8	5/8-18
49-6-4	3/8	1/4	5/8-18
49-6-6	3/8	3/8	5/8-18
49-6-8	3/8	1/2	5/8-18
49-6-12	3/8	3/4	5/8-18
49-8-4	1/2	1/4	3/4-16
49-8-6	1/2	3/8	3/4-16
49-8-8	1/2	1/2	3/4-16
49-8-12	1/2	3/4	3/4-16
49-10-4	5/8	1/4	7/8-14
49-10-6	5/8	3/8	7/8-14
49-10-8	5/8	1/2	7/8-14
49-10-12	5/8	3/4	7/8-14
49-12-6	3/4	3/8	1 1/16-14
49-12-8	3/4	1/2	1 1/16-14
49-12-12	3/4	3/4	1 1/16-14
49-12-16	3/4	1	1 1/16-14
49-14-12	7/8	3/4	1 1/4-12
49-14-16	7/8	1	1 1/4-12
49-16-12	1	3/4	1-11-1/2
49-16-16	1	1	1-11-1/2

# 45° FLARE FITTINGS

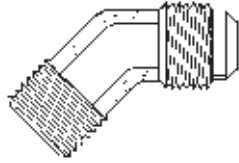

## 45° ELBOW 49-45

PART NO.	TUBE SIZE	PIPE THREAD	STRAIGHT THREAD
49-45-4-2	1/4	1/8	7/16-20
49-45-4-4	1/4	1/4	7/16-20
49-45-5-2	5/16	1/8	1/2-20
49-45-5-4	5/16	1/4	1/2-20
49-45-6-2	3/8	1/8	5/8-18
49-45-6-4	3/8	1/4	5/8-18
49-45-6-6	3/8	3/8	5/8-18
49-45-8-4	1/2	1/4	3/4-16
49-45-8-6	1/2	3/8	3/4-16
49-45-8-8	1/2	1/2	3/4-16
49-45-10-6	5/8	3/8	7/8-14
49-45-10-8	5/8	1/2	7/8-14
49-45-12-8	3/4	1/2	1 1/16-14

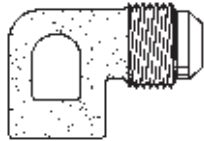

## FEMALE ELBOW 50

PART NO.	TUBE SIZE	PIPE THREAD	STRAIGHT THREAD
50-3-2	3/16	1/8	3/8-24
50-4-2	1/4	1/8	7/16-20
50-4-4	1/4	1/4	7/16-20
50-4-6	1/4	3/8	7/16-20
50-4-8	1/4	1/2	7/16-20
50-5-2	5/16	1/8	1/2-20
50-5-4	5/16	1/4	1/2-20
50-6-2	3/8	1/8	5/8-18
50-6-4	3/8	1/4	5/8-18
50-6-6	3/8	3/8	5/8-18
50-6-8	3/8	1/2	5/8-18
50-6-12	3/8	3/4	5/8-18
50-8-4	1/2	1/4	3/4-16
50-8-6	1/2	3/8	3/4-16
50-8-8	1/2	1/2	3/4-16
50-8-12	1/2	3/4	3/4-16
50-10-6	5/8	3/8	7/8-14
50-10-8	5/8	1/2	7/8-14
50-10-12	5/8	3/4	7/8-14
50-12-8	3/4	1/2	1 1/16-14
50-12-12	3/4	3/4	1 1/16-14
50-14-12	7/8	3/4	1 1/4-12

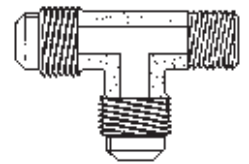

## MALE RUN TEE 51

PART NO.	TUBE SIZE	PIPE THREAD	STRAIGHT THREAD
51-2-2	1/8	1/8	5/16-24
51-3-2	3/16	1/8	3/8-24
51-4-2	1/4	1/8	7/16-20
51-4-4	1/4	1/4	7/16-20
51-4-6	1/4	3/8	7/16-20
51-5-2	5/16	1/8	1/2-20
51-5-4	5/16	1/4	1/2-20
51-6-2	3/8	1/8	5/8-18
51-6-4	3/8	1/4	5/8-18
51-6-6	3/8	3/8	5/8-18
51-6-8	3/8	1/2	5/8-18
51-8-4	1/2	1/4	3/4-16
51-8-6	1/2	3/8	3/4-16
51-8-8	1/2	1/2	3/4-16
51-10-6	5/8	3/8	7/8-14
51-10-8	5/8	1/2	7/8-14
51-12-8	3/4	1/2	1 1/16-14
51-12-12	3/4	3/4	1 1/4-12

## UNION ELBOW 55

PART NO.	TUBE SIZE	STRAIGHT THREAD
55-2	1/8	5/16-24
55-3	3/16	3/8-24
55-4	1/4	7/16-20
55-5	5/16	1/2-20
55-6	3/8	5/8-18
55-8	1/2	3/4-16
55-10	5/8	7/8-14
55-12	3/4	1 1/16-14
55-14	7/8	1 1/4-12

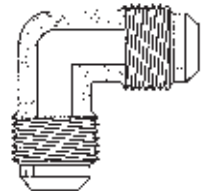
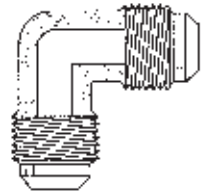

## REDUCING ELBOW 55R

PART NO.	1 TUBE SIZE	2 TUBE SIZE	1 STRAIGHT THREAD	2 STRAIGHT THREAD
55R-6-4	3/8	1/4	5/8-18	7/16-20
55R-8-4	1/2	1/4	3/4-16	7/16-20
55R-8-6	1/2	3/8	3/4-16	5/8-18
55R-10-6	5/8	3/8	7/8-14	5/8-18
55R-10-8	5/8	1/2	7/8-14	3/4-16
55R-12-8	3/4	1/2	1 1/16-14	3/4-16
55R-12-10	3/4	5/8	1 1/16-14	7/8-14

# INVERTED FLARE TUBE FITTINGS

## NUT-BRASS 105

PART NO.	TUBE SIZE	STRAIGHT THREAD
105-2	1/8	5/16-28
105-3	3/16	3/8-24
105-4	1/4	7/16-24
105-5	5/16	1/2-20
105-6	3/8	5/8-18
105-8	1/2	3/4-18

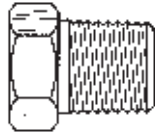

## STEEL NUT-ZINC CHROMATE 105S

PART NO.	TUBE SIZE	STRAIGHT THREAD
105S-3	3/16	3/8-24
105S-4	1/4	7/16-24
105S-5	5/16	1/2-20
105S-6	3/8	5/8-18
105S-8	1/2	3/4-18
105S-10	5/8	7/8-18
105S-12	3/4	1 1/16-16
105S-14	7/8	1 3/16-16

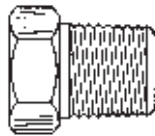

## UNION 300

PART NO.	TUBE SIZE	STRAIGHT THREAD
300-2	1/8	5/16-28
300-3	3/16	3/8-24
300-4	1/4	7/16-24
300-5	5/16	1/2-20
300-6	3/8	5/8-18
300-8	1/2	3/4-18



## FEMALE CONNECTOR 46IF

PART NO.	TUBE SIZE	PIPE THREAD	STRAIGHT THREAD
46IF-3-2	3/16	1/8	3/8-24
46IF-4-2	1/4	1/8	7/16-24
46IF-5-2	5/16	1/8	1/2-20
46IF-6-4	3/8	1/4	5/8-18
46IF-8-6	1/2	3/8	3/4-18

## MALE CONNECTOR 200

PART NO.	TUBE SIZE	PIPE THREAD	STRAIGHT THREAD
200-2-2	1/8	1/8	5/16-28
200-3-2	3/16	1/8	3/8-24
200-4-2	1/4	1/8	7/16-24
200-4-4	1/4	1/4	7/16-24
200-5-2	5/16	1/8	1/2-20
200-5-4	5/16	1/4	1/2-20
200-6-2	3/8	1/8	5/8-18
200-6-4	3/8	1/4	5/8-18
200-6-6	3/8	3/8	5/8-18
200-8-4	1/2	1/4	3/4-18
200-8-6	1/2	3/8	3/4-18
200-8-8	1/2	1/2	3/4-18
200-10-8	5/8	1/2	7/8-18
200-12-12	3/4	3/4	1 1/16-16
200-14-12	7/8	3/4	1 3/16-16

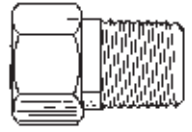

## MALE ELBOW 400

PART NO.	TUBE SIZE	PIPE THREAD	STRAIGHT THREAD
400-2-2	1/8	1/8	5/16-28
400-3-2	3/16	1/8	3/8-24
400-4-2	1/4	1/8	7/16-24
400-4-4	1/4	1/4	7/16-24
400-5-2	5/16	1/8	1/2-20
400-5-4	5/16	1/4	1/2-20
400-6-2	3/8	1/8	5/8-18
400-6-4	3/8	1/4	5/8-18
400-6-6	3/8	3/8	5/8-18
400-8-4	1/2	1/4	3/4-18
400-8-6	1/2	3/8	3/4-18
400-8-8	1/2	1/2	3/4-18
400-10-6	5/8	3/8	7/8-18
400-10-8	5/8	1/2	7/8-18
400-14-12	7/8	3/4	1 3/16-16

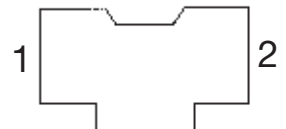

## FEMALE BRANCH TEE 252IF

PART NO.	1&2 TUBE SIZE	3 PIPE THREAD	STRAIGHT THREAD
252IF-5-2	5/16	1/8	1/2-20
252IF-6-4	3/8	1/4	5/8-18

# INVERTED FLARE TUBE FITTINGS

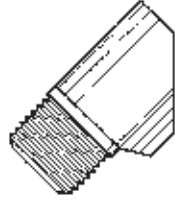

## 45° ELBOW 350

PART NO.	TUBE SIZE	PIPE THREAD	STRAIGHT THREAD
350-3-2	3/16	1/8	3/8-24
350-4-2	1/4	1/8	7/16-24
350-5-2	5/16	1/8	1/2-20
350-5-4	5/16	1/4	1/2-20
350-6-4	3/8	1/4	5/8-18
350-8-6	1/2	3/8	3/4-18
350-10-8	5/8	1/2	7/8-18

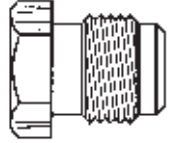

## PLUG STEEL 106

PART NO.	TUBE SIZE	STRAIGHT THREAD
106-3	3/16	3/8-24
106-4	1/4	7/16-24
106-5	5/16	1/2-20
106-6	3/8	5/8-18

## UNION ELBOW 255IF

PART NO.	TUBE SIZE	STRAIGHT THREAD
255IF-4	1/4	7/16-24

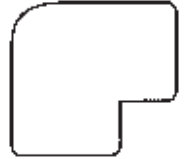

# THREADED SLEEVE FITTINGS

## TUBE NUT 6100

*Threaded sleeves*

PART NO.	TUBE SIZE
6100-2	1/8
6100-3	3/16
6100-4	1/4
6100-5	5/16
6100-6	3/8



## HALF UNION NUT 6200

PART NO.	TUBE SIZE	PIPE THREAD	STRAIGHT THREAD
6200-2-2	1/8	1/8	5/16-24
6200-3-2	3/16	1/8	3/8-24
6200-4-2	1/4	1/8	7/16-24
6200-4-4	1/4	1/4	7/16-24
6200-5-2	5/16	1/8	1/2-20
6200-6-4	3/8	1/4	9/16-20

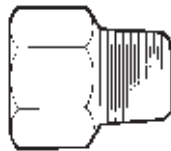

## HALF UNION 90° 6400

PART NO.	TUBE SIZE	PIPE THREAD	STRAIGHT THREAD
6400-2-2	1/8	1/8	5/16-24
6400-3-2	3/16	1/8	3/8-24
6400-4-2	1/4	1/8	7/16-24
6400-4-4	1/4	1/4	7/16-24
6400-5-2	5/16	1/8	1/2-20
6400-6-4	3/8	1/4	9/16-20



# REFRIGERATION 45° FLARE FITTINGS

## REFRIGERANT DRUM ADAPTER K1

PART NO.	TUBE O.D.	PIPE THREAD
K1-1	1/4	3/4
K1-3	3/8	3/4
K1-5	1/2	3/4
K1-8	1/4	1/2

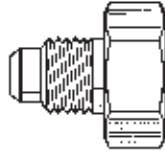

Gasket furnished with each adapter

## GASKETS FOR DRUM ADAPTERS P10

PART NO.	
P10-A	For K1-K3-K5
P10-B	For K1-8

## COPPER FLARE GASKET B2

PART NO.	TUBE SIZE
B2-3	3/16
B2-4	1/4
B2-5	5/16
B2-6	3/8
B2-8	1/2
B2-10	5/8
B2-12	3/4



## SEAL BONNET B1

PART NO.	TUBE SIZE
B1-3	3/16
B1-4	1/4
B1-5	5/16
B1-6	3/8
B1-8	1/2
B1-10	5/8
B1-12	3/4

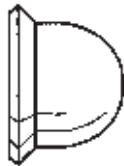

## LONG FORGED NUT N4

PART NO.	TUBE SIZE	STRAIGHT THREAD
N4-4	1/4	7/16-20
N4-5	5/16	1/2-20
N4-6	3/8	5/8-18
N4-8	1/2	3/4-16
N4-10	5/8	7/8-14
N4-12	3/4	1 1/16-14

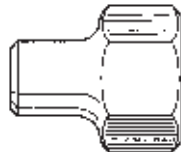

## SHORT FORGED NUT NS4

PART NO.	TUBE SIZE	STRAIGHT THREAD
NS4-3	3/16	3/8-24
NS4-4	1/4	7/16-20
NS4-5	5/16	1/2-20
NS4-6	3/8	5/8-18
NS4-8	1/2	3/4-16
NS4-10	5/8	7/8-14
NS4-12	3/4	1 1/16-14
NS4-14	7/8	1 1/4-12
NS4-16	1	1 3/8-12



## SHORT FORGED REDUCING NUT NSR4

PART NO.	TUBE SIZE	STRAIGHT THREAD
NSR4-4-3	3/16	7/16-20
NSR4-5-4	1/4	1/2-20
NSR4-6-4	1/4	5/8-18
NSR4-6-5	5/16	5/8-18
NSR4-8-6	3/8	3/4-16
NSR4-10-6	3/8	7/8-14
NSR4-10-8	1/2	7/8-14
NSR4-12-8	1/2	1 1/16-14
NSR4-12-10	5/8	1 1/16-14



## EXTRA HEAVY SHORT FORGED FLARE NUT NS4H

PART NO.	TUBE SIZE	STRAIGHT THREAD
NS4H-4	1/4	7/16-20
NS4H-5	5/16	1/2-20
NS4H-6	3/8	5/8-18
NS4H-8	1/2	3/4-16
NS4H-10	5/8	7/8-14
NS4H-12	3/4	1 1/16-14



## FROST FREE SHORT FORGED FLARE NUT NST4

PART NO.	TUBE SIZE	STRAIGHT THREAD
NST4-4	1/4	7/16-20
NST4-6	3/8	5/8-18
NST4-8	1/2	3/4-16
NST4-10	5/8	7/8-14
NST4-12	3/4	1 1/16-14

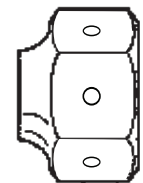

# REFRIGERATION 45° FLARE FITTINGS

## SWIVEL NUT CONNECTOR US4

PART NO.	TUBE SIZE	STRAIGHT THREAD
US4-4	1/4	7/16-20
US4-5	5/16	1/2-20
US4-6	3/8	5/8-18
US4-8	1/2	3/4-16
US4-10	5/8	7/8-14
US4-12	3/4	1 1/16-14

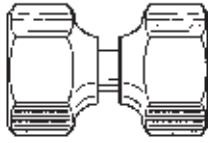

## LONG NUT N2

PART NO.	TUBE SIZE	STRAIGHT THREAD
N2-2	1/8	5/16-24
N2-3	3/16	3/8-24
N2-4	1/4	7/16-20
N2-5	5/16	1/2-20
N2-6	3/8	5/8-18
N2-8	1/2	3/4-16
N2-10	5/8	7/8-14
N2-12	3/4	1 1/16-14

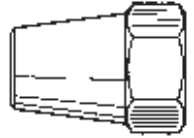

## REDUCING SWIVEL NUT CONNECTOR URS4

PART NO.	TUBE SIZE	TUBE SIZE	STRAIGHT THREAD	STRAIGHT THREAD
URS4-6-4	3/8	1/4	5/8-18	7/16-20
URS4-8-6	1/2	3/8	3/4-16	5/8-18
URS4-10-8	5/8	1/2	7/8-14	3/4-16

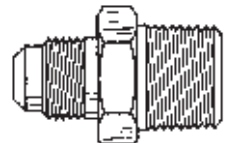

## 90° SWIVEL ELBOW ES4

PART NO.	TUBE SIZE	STRAIGHT THREAD
ES4-4-4	1/4	7/16-20
ES4-6-6	3/8	5/8-18
ES4-8-8	1/2	3/4-16
ES4-10-10	5/8	7/8-14
ES4-12-12	3/4	1 1/16-14

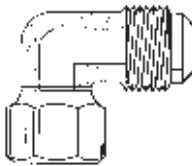

## MALE CONNECTOR U1

PART NO.	TUBE SIZE	PIPE THREAD	STRAIGHT THREAD
U1-2-A	1/8	1/8	5/16-24
U1-3-A	3/16	1/8	3/8-24
U1-3-B	3/16	1/4	3/8-24
U1-4-A	1/4	1/8	7/16-20
U1-4-B	1/4	1/4	7/16-20
U1-4-C	1/4	3/8	7/16-20
U1-4-D	1/4	1/2	7/16-20
U1-5-A	5/16	1/8	1/2-20
U1-5-B	5/16	1/4	1/2-20
U1-5-C	5/16	3/8	1/2-20
U1-6-A	3/8	1/8	5/8-18
U1-6-B	3/8	1/4	5/8-18
U1-6-C	3/8	3/8	5/8-18
U1-6-D	3/8	1/2	5/8-18
U1-6-E	3/8	3/4	5/8-18
U1-8-A	1/2	1/8	3/4-16
U1-8-B	1/2	1/4	3/4-16
U1-8-C	1/2	3/8	3/4-16
U1-8-D	1/2	1/2	3/4-16
U1-8-E	1/2	3/4	3/4-16
U1-10-B	5/8	1/4	7/8-14
U1-10-C	5/8	3/8	7/8-14
U1-10-D	5/8	1/2	7/8-14
U1-10-E	5/8	3/4	7/8-14
U1-12-C	3/4	3/8	1 1/16-14
U1-12-D	3/4	1/2	1 1/16-14
U1-12-E	3/4	3/4	1 1/16-14
U1-14-E	7/8	3/4	1 1/4-12
U1-14-F	7/8	1	1 1/4-12
U1-16-E	1	3/4	1 3/8-12
U1-16-F	1	1	1 3/8-12

## FLARE ADAPTER US5

PART NO.	TUBE SIZE	STRAIGHT THREAD	SOLDER
US5-4	1/4	7/16-20	1/4
US5-6	3/8	5/8-18	3/8
US5-8	1/2	3/4-16	1/2
US5-10	5/8	7/8-14	5/8
US5-12	3/4	1 1/16-14	3/4

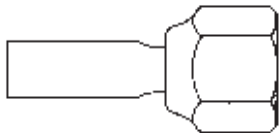

## SHORT NUT N1

PART NO.	TUBE SIZE	STRAIGHT THREAD
N1-2	1/8	5/16-24
N1-3	3/16	3/8-24
N1-4	1/4	7/16-20
N1-5	5/16	1/2-20
N1-6	3/8	5/8-18
N1-8	1/2	3/4-16
N1-10	5/8	7/8-14
N1-12	3/4	1 1/16-14
N1-14	7/8	1 1/4-12
N1-16	1	1 3/8-12

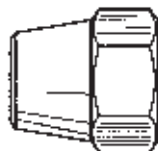



# REFRIGERATION 45° FLARE FITTINGS

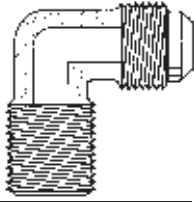

## MALE ELBOW E1

PART NO.	TUBE SIZE	PIPE THREAD	STRAIGHT THREAD
E1-2-A	1/8	1/8	5/16-24
E1-3-A	3/16	1/8	3/8-24
E1-3-B	3/16	1/4	3/8-24
E1-4-A	1/4	1/8	7/16-20
E1-4-B	1/4	1/4	7/16-20
E1-4-C	1/4	3/8	7/16-20
E1-4-D	1/4	1/2	7/16-20
E1-5-A	5/16	1/8	1/2-20
E1-5-B	5/16	1/4	1/2-20
E1-5-C	5/16	3/8	1/2-20
E1-6-A	3/8	1/8	5/8-18
E1-6-B	3/8	1/4	5/8-18
E1-6-C	3/8	3/8	5/8-18
E1-6-D	3/8	1/2	5/8-18
E1-6-E	3/8	3/4	5/8-18
E1-8-A	1/2	1/8	3/4-16
E1-8-B	1/2	1/4	3/4-16
E1-8-C	1/2	3/8	3/4-16
E1-8-D	1/2	1/2	3/4-16
E1-8-E	1/2	3/4	3/4-16
E1-10-B	5/8	1/4	7/8-14
E1-10-C	5/8	3/8	7/8-14
E1-10-D	5/8	1/2	7/8-14
E1-10-E	5/8	3/4	7/8-14
E1-12-C	3/4	3/8	1 1/16-14
E1-12-D	3/4	1/2	1 1/16-14
E1-12-E	3/4	3/4	1 1/16-14
E1-14-E	7/8	3/4	1 1/4-12
E1-14-F	7/8	1	1 1/4-12
E1-16-E	1	3/4	1 3/8-12
E1-16-F	1	1	1 3/8-12

## UNION ELBOW E2

PART NO.	TUBE SIZE	STRAIGHT THREAD
E2-2	1/8	5/16-24
E2-3	3/16	3/8-24
E2-4	1/4	7/16-20
E2-5	5/16	1/2-20
E2-6	3/8	5/8-18
E2-8	1/2	3/4-16
E2-10	5/8	7/8-14
E2-12	3/4	1 1/16-14
E2-14	7/8	1 1/4-12

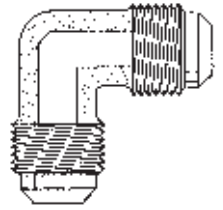
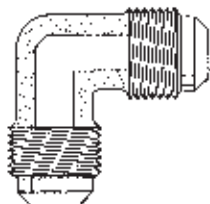

## UNION ELBOW - REDUCING ER2

PART NO.	TUBE SIZE	TUBE SIZE	STRAIGHT THREAD	STRAIGHT THREAD
ER2-6-4	3/8	1/4	5/8-18	7/16-20
ER2-6-5	3/8	5/16	5/8-18	1/2-20
ER2-8-4	1/2	1/4	3/4-16	7/16-20
ER2-8-6	1/2	3/8	3/4-16	5/8-18
ER2-10-6	5/8	3/8	7/8-14	5/8-18
ER2-10-8	5/8	1/2	7/8-14	3/4-16
ER2-12-8	3/4	1/2	1 1/16-14	3/4-16
ER2-12-10	3/4	5/8	1 1/16-14	7/8-14

## FEMALE ELBOW E3

PART NO.	TUBE SIZE	PIPE THREAD	STRAIGHT THREAD
E3-3-A	3/16	1/8	3/8-24
E3-4-A	1/4	1/8	7/16-20
E3-4-B	1/4	1/4	7/16-20
E3-4-C	1/4	3/8	7/16-20
E3-4-D	1/4	1/2	7/16-20
E3-5-A	5/16	1/8	1/2-20
E3-5-B	5/16	1/4	1/2-20
E3-6-A	3/8	1/8	5/8-18
E3-6-B	3/8	1/4	5/8-18
E3-6-C	3/8	3/8	5/8-18
E3-6-D	3/8	1/2	5/8-18
E3-6-E	3/8	3/4	5/8-18
E3-8-B	1/2	1/4	3/4-16
E3-8-C	1/2	3/8	3/4-16
E3-8-D	1/2	1/2	3/4-16
E3-8-E	1/2	3/4	3/4-16
E3-10-C	5/8	3/8	7/8-14
E3-10-D	5/8	1/2	7/8-14
E3-10-E	5/8	3/4	7/8-14
E3-12-D	3/4	1/2	1 1/16-14
E3-12-E	3/4	3/4	1 1/16-14
E3-14-E	7/8	3/4	1 1/4-12

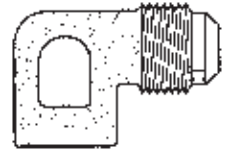

# REFRIGERATION 45° FLARE FITTINGS

## FORGED MALE FLARE TO FEMALE FLARE ELBOW E4

PART NO.	TUBE SIZE	STRAIGHT THREAD
E4-4-4	1/4 - 1/4	7/16-20
E4-6-6	3/8 - 3/8	5/8-18
E4-8-8	1/2 - 1/2	3/4-16

Supplied with copper gasket

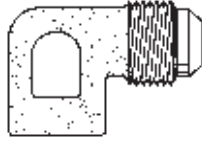

## 45° ELBOW E5

PART NO.	TUBE SIZE	PIPE THREAD	STRAIGHT THREAD
E5-3-A	3/16	1/8	3/8-24
E5-4-A	1/4	1/8	7/16-20
E5-4-B	1/4	1/4	7/16-20
E5-4-C	1/4	3/8	7/16-20
E5-5-A	5/16	1/8	1/2-20
E5-5-B	5/16	1/4	1/2-20
E5-6-A	3/8	1/8	5/8-18
E5-6-B	3/8	1/4	5/8-18
E5-6-C	3/8	3/8	5/8-18
E5-6-D	3/8	1/2	5/8-18
E5-8-B	1/2	1/4	3/4-16
E5-8-C	1/2	3/8	3/4-16
E5-8-D	1/2	1/2	3/4-16
E5-10-C	5/8	3/8	7/8-14
E5-10-D	5/8	1/2	7/8-14
E5-12-D	3/4	1/2	1 1/16-14
E5-12-E	3/4	3/4	1 1/16-14

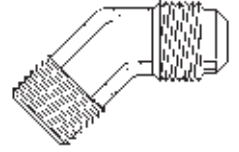

## FORGED SOLDER ELL FLARE TO SOLDER ES2

PART NO.	TUBE SIZE	STRAIGHT THREAD	SOLDER O.D.
ES2-4-4	1/4 - 1/4	7/16-20	1/4
ES2-6-6	3/8 - 3/8	5/8-18	3/8
ES2-8-8	1/2 - 1/2	3/4-16	1/2

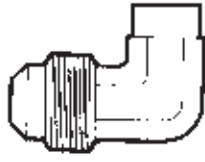

## UNION U2

PART NO.	TUBE SIZE	STRAIGHT THREAD
U2-2	1/8	5/16-24
U2-3	3/16	3/8-24
U2-4	1/4	7/16-20
U2-5	5/16	1/2-20
U2-6	3/8	5/8-18
U2-8	1/2	3/4-16
U2-10	5/8	7/8-14
U2-12	3/4	1 1/16-14
U2-14	7/8	1 1/4-12
U2-X-4 (Extra Long)	1/4	7/16-20

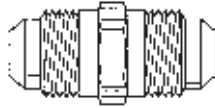

## FLARE TO SOLDER US3

PART NO.	TUBE SIZE	SOLDER O.D.	STRAIGHT THREAD
US3-4-4	1/4	1/4	7/16-20
US3-4-5	1/4	5/16	7/16-20
US3-4-6	1/4	3/8	7/16-20
US3-6-4	3/8	1/4	5/8-18
US3-6-5	3/8	5/16	5/8-18
US3-6-6	3/8	3/8	5/8-18
US3-6-8	3/8	1/2	5/8-18
US3-6-10	3/8	5/8	5/8-18
US3-8-6	1/2	3/8	3/4-16
US3-8-8	1/2	1/2	3/4-16
US3-8-10	1/2	5/8	3/4-16
US3-8-12	1/2	3/4	3/4-16
US3-10-8	5/8	1/2	7/8-14
US3-10-10	5/8	5/8	7/8-14
US3-10-12	5/8	3/4	7/8-14
US3-10-14	5/8	7/8	7/8-14
US3-12-12	3/4	3/4	1 1/16-14
US3-12-14	3/4	7/8	1 1/16-14

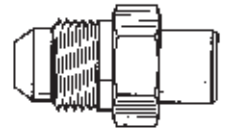

## UNION REDUCERS UR2

PART NO.	TUBE SIZE	TUBE SIZE	STRAIGHT THREAD	STRAIGHT THREAD
UR2-4-3	1/4	3/16	7/16-20	3/8-24
UR2-5-4	5/16	1/4	1/2-20	7/16-20
UR2-6-4	3/8	1/4	5/8-18	7/16-20
UR2-6-5	3/8	5/16	5/8-18	1/2-20
UR2-8-4	1/2	1/4	3/4-16	7/16-20
UR2-8-6	1/2	3/8	3/4-16	5/8-18
UR2-10-6	5/8	3/8	7/8-14	5/8-18
UR2-10-8	5/8	1/2	7/8-14	3/4-16
UR2-12-8	3/4	1/2	1 1/16-14	3/4-16
UR2-12-10	3/4	5/8	1 1/16-14	7/8-14

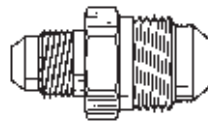

# REFRIGERATION 45° FLARE FITTINGS

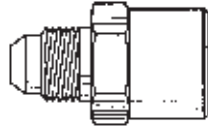

## FEMALE CONNECTOR U3

PART NO.	TUBE SIZE	PIPE THREAD	STRAIGHT THREAD
U3-2-A	1/8	1/8	5/16-24
U3-3-A	3/16	1/8	3/8-24
U3-4-A	1/4	1/8	7/16-20
U3-4-B	1/4	1/4	7/16-20
U3-4-C	1/4	3/8	7/16-20
U3-4-D	1/4	1/2	7/16-20
U3-5-A	5/16	1/8	1/2-20
U3-5-B	5/16	1/4	1/2-20
U3-6-A	3/8	1/8	5/8-18
U3-6-B	3/8	1/4	5/8-18
U3-6-C	3/8	3/8	5/8-18
U3-6-D	3/8	1/2	5/8-18
U3-6-E	3/8	3/4	5/8-18
U3-8-B	1/2	1/4	3/4-16
U3-8-C	1/2	3/8	3/4-16
U3-8-D	1/2	1/2	3/4-16
U3-8-E	1/2	3/4	3/4-16
U3-10-B	5/8	1/4	7/8-14
U3-10-C	5/8	3/8	7/8-14
U3-10-D	5/8	1/2	7/8-14
U3-10-E	5/8	3/4	7/8-14
U3-12-D	3/4	1/2	1 1/16-14
U3-12-E	3/4	3/4	1 1/16-14
U3-14-E	7/8	3/4	1 1/4-12

## CAP NUT N5

PART NO.	TUBE SIZE	STRAIGHT THREAD
N5-3	3/16	3/8-24
N5-4	1/4	7/16-20
N5-5	5/16	1/2-20
N5-6	3/8	5/8-18
N5-8	1/2	3/4-16
N5-10	5/8	7/8-14
N5-12	3/4	1 1/16-24



## CAP NUT EXTRA HEAVY N7

PART NO.	TUBE SIZE	STRAIGHT THREAD
N7-4	1/4	7/16-20
N7-5	5/16	1/2-20
N7-6	3/8	5/8-18
N7-8	1/2	3/4-16
N7-10	5/8	7/8-14

## FLARED SEAL PLUG P2

PART NO.	TUBE SIZE	STRAIGHT THREAD
P2-3	3/16	3/8-24
P2-4	1/4	7/16-20
P2-5	5/16	1/2-20
P2-6	3/8	5/8-18
P2-8	1/2	3/4-16
P2-10	5/8	7/8-14
P2-12	3/4	1 1/16-14

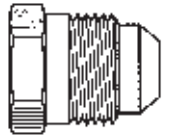

## UNION TEE T2

PART NO.	TUBE SIZE	STRAIGHT THREAD
T2-2	1/8	5/16-24
T2-3	3/16	3/8-24
T2-4	1/4	7/16-20
T2-5	5/16	1/2-20
T2-6	3/8	5/8-18
T2-8	1/2	3/4-16
T2-10	5/8	7/8-14
T2-12	3/4	1 1/16-14
T2-14	7/8	1 1/4-12

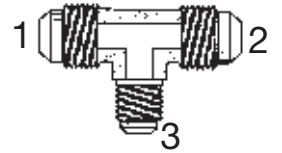
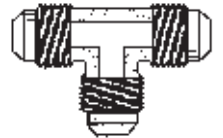

## UNION TEE TR2

PART NO.	1&2 TUBE SIZE	3 TUBE SIZE	1&2 STRAIGHT THREAD	3 STRAIGHT THREAD
TR2-4-4-6	1/4	3/8	7/16-20	5/8-18
TR2-4-4-8	1/4	1/2	7/16-20	3/4-16
TR2-6-6-4	3/8	1/4	5/8-18	7/16-20
TR2-6-6-8	3/8	1/2	5/8-18	3/4-16
TR2-8-8-4	1/2	1/4	3/4-16	7/16-20
TR2-8-8-6	1/2	3/8	3/4-16	5/8-18
TR2-8-8-10	1/2	5/8	3/4-16	7/8-14
TR2-8-8-12	1/2	3/4	3/4-16	1 1/16-14
TR2-10-10-4	5/8	1/4	7/8-14	7/16-20
TR2-10-10-6	5/8	3/8	7/8-14	5/8-18
TR2-10-10-8	5/8	1/2	7/8-14	3/4-16
TR2-10-10-12	5/8	3/4	7/8-14	1 1/16-14
TR2-12-12-10	3/4	5/8	1 1/16-14	7/8-14

# REFRIGERATION 45° FLARE FITTINGS

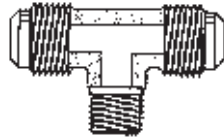

## MALE BRANCH TEE T1

PART NO.	TUBE SIZE	PIPE THREAD	STRAIGHT THREAD
T1-2A	1/8	1/8	5/16-24
T1-3A	3/16	1/8	3/8-24
T1-4A	1/4	1/8	7/16-20
T1-4B	1/4	1/4	7/16-20
T1-4C	1/4	3/8	7/16-20
T1-4D	1/4	1/2	7/16-20
T1-5A	5/16	1/8	1/2-20
T1-5B	5/16	1/4	1/2-20
T1-6A	3/8	1/8	5/8-18
T1-6B	3/8	1/4	5/8-18
T1-6C	3/8	3/8	5/8-18
T1-6D	3/8	1/2	5/8-18
T1-8B	1/2	1/4	3/4-16
T1-8C	1/2	3/8	3/4-16
T1-8D	1/2	1/2	3/4-16
T1-10C	5/8	3/8	7/8-14
T1-10D	5/8	1/2	7/8-14
T1-12D	3/4	1/2	1 1/16-14
T1-12E	3/4	3/4	1 1/16-14

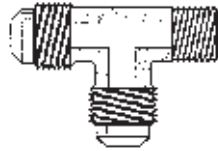

## MALE RUN TEE T3

PART NO.	TUBE SIZE	PIPE THREAD	STRAIGHT THREAD
T3-2A	1/8	1/8	5/16-24
T3-3A	3/16	1/8	3/8-24
T3-4A	1/4	1/8	7/16-20
T3-4B	1/4	1/4	7/16-20
T3-4C	1/4	3/8	7/16-20
T3-5A	5/16	1/8	1/2-20
T3-5B	5/16	1/4	1/2-20
T3-6A	3/8	1/8	5/8-18
T3-6B	3/8	1/4	5/8-18
T3-6C	3/8	3/8	5/8-18
T3-6D	3/8	1/2	5/8-18
T3-8B	1/2	1/4	3/4-16
T3-8C	1/2	3/8	3/4-16
T3-8D	1/2	1/2	3/4-16
T3-10C	5/8	3/8	7/8-14
T3-10D	5/8	1/2	7/8-14
T3-12D	3/4	1/2	1 1/16-14
T3-12E	3/4	3/4	1 1/4-12

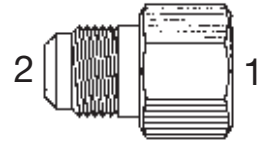

## REDUCER - FEMALE FLARE TO MALE FLARE UR3

PART NO.	1 TUBE SIZE	2 TUBE SIZE	1 STRAIGHT THREAD	2 STRAIGHT THREAD
UR3-3-4	3/16	1/4	3/8-24	7/16-20
UR3-4-3	1/4	3/16	7/16-20	3/8-24
UR3-4-5	1/4	5/16	7/16-20	1/2-20
UR3-4-6	1/4	3/8	7/16-20	5/8-18
UR3-4-8	1/4	1/2	7/16-20	3/4-16
UR3-5-4	5/16	1/4	1/2-20	7/16-20
UR3-5-6	5/16	3/8	1/2-20	5/8-18
UR3-6-4	3/8	1/4	5/8-18	7/16-20
UR3-6-5	3/8	5/16	5/8-18	1/2-20
UR3-6-8	3/8	1/2	5/8-18	3/4-16
UR3-6-10	3/8	5/8	5/8-18	7/8-14
UR3-8-4	1/2	1/4	3/4-16	7/16-20
UR3-8-6	1/2	3/8	3/4-16	5/8-18
UR3-8-10	1/2	5/8	3/4-16	7/8-14
UR3-8-12	1/2	3/4	3/4-16	1 1/16-14
UR3-10-4	5/8	1/4	7/8-14	7/16-20
UR3-10-6	5/8	3/8	7/8-14	5/8-18
UR3-10-8	5/8	1/2	7/8-14	3/4-16
UR3-10-12	5/8	3/4	7/8-14	1 1/16-14
UR3-12-10	3/4	5/8	1 1/16-14	7/8-14

Supplied with copper gasket

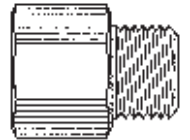

## FEMALE FLARE TO MALE PIPE THREAD U5

PART NO.	TUBE SIZE	PIPE THREAD	STRAIGHT THREAD
U5-4A	1/4	1/8	7/16-20
U5-4B	1/4	1/4	7/16-20
U5-6B	3/8	1/4	5/8-18
U5-6C	3/8	3/8	5/8-18
U5-8B	1/2	1/4	3/4-16
U5-8C	1/2	3/8	3/4-16
U5-8D	1/2	1/2	3/4-16
U5-10C	5/8	3/8	7/8-14
U5-10D	5/8	1/2	7/8-14

Supplied with copper gasket

# REFRIGERATION 45° FLARE FITTINGS

## FLARE SEAL CAPS – FINGER TIGHTENING NFT5

PART NO.	TUBE SIZE	STRAIGHT THREAD
NFT5-4	1/4	7/16-20
NFT5-6	3/8	5/8-18



## FUSIBLE PIPE PLUGS FP

PART NO.	PIPE THREAD
----------	-------------

### (165°F.)

FP-A-165°	1/8
FP-B-165°	1/4
FP-C-165°	3/8
FP-D-165°	1/2

### (212°F.)

FP-A-212°	1/8
FP-B-212°	1/4
FP-C-212°	3/8
FP-D-212°	1/2

### (280°F.)

FP-A-280°	1/8
FP-B-280°	1/4
FP-C-280°	3/8
FP-D-280°	1/2



## CROSS C1

PART NO.	TUBE SIZE	STRAIGHT THREAD
C1-4	1/4	7/16-20
C1-6	3/8	5/8-18
C1-8	1/2	3/4-16
C1-10	5/8	7/8-14

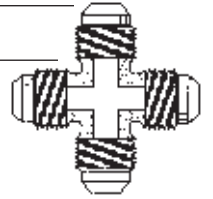

## EXTRA LONG HALF UNION COUPLINGS U1X

PART NO.	FEMALE FLARE	PIPE THREAD	STRAIGHT THREAD
U1X-4A	1/4	1/8	7/16-20
U1X-4B	1/4	1/4	7/16-20



## FLARED UNION – FEMALE FLARE TO FEMALE FLARE U4

PART NO.	TUBE SIZE	STRAIGHT THREAD
U4-4	1/4	7/16-20
U4-6	3/8	5/8-18
U4-8	1/2	3/4-16
U4-10	5/8	7/8-14
U4-12	3/4	1 1/16-14



Supplied with 2 copper gaskets

## FORGED FEMALE BRANCH TEE T5

PART NO.	1&2 TUBE SIZE	PIPE THREAD	1&2 STRAIGHT THREAD
T5-4A	1/4	1/8	7/16-20
T5-4B	1/4	1/4	7/16-20
T5-6B	3/8	1/4	5/8-18

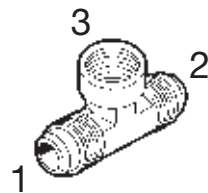

## FEMALE ADAPTER U6

PART NO.	FEMALE FLARE	PIPE THREAD	STRAIGHT THREAD
U6-4A	1/4	1/8	7/16-20
U6-4B	1/4	1/4	7/16-20



Supplied with 1 copper gasket

## FORGED FEMALE FLARE – BRANCH TEE T6

PART NO.	1&2 TUBE SIZE	3 TUBE SIZE	1,2,3 STRAIGHT THREAD
T6-4	1/4	1/4	7/16-20

# BRASS PIPE FITTINGS

## HEXAGON BRASS PIPE PLUG P3

PART NO.	PIPE THREAD
P3-A	1/8
P3-B	1/4
P3-C	3/8
P3-D	1/2
P3-E	3/4
P3-F	1

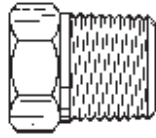

## HEX COUPLINGS PC

PART NO.	PIPE THREAD
PC-A	1/8
PC-B	1/4
PC-C	3/8
PC-D	1/2
PC-E	3/4

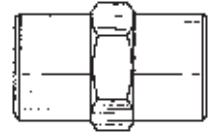

## PIPE ADAPTER R1

PART NO.	1 PIPE THREAD	2 PIPE THREAD
R1-AB	1/8	1/4

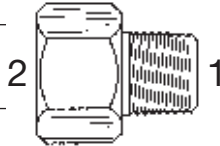

## HEXAGON PIPE BUSHING R1

PART NO.	1 PIPE THREAD	2 PIPE THREAD
R1-BA	1/4	1/8
R1-CA	3/8	1/8
R1-CB	3/8	1/4
R1-DA	1/2	1/8
R1-DB	1/2	1/4
R1-DC	1/2	3/8
R1-EA	3/4	1/8
R1-EB	3/4	1/4
R1-EC	3/4	3/8
R1-ED	3/4	1/2
R1-FB	1	1/4
R1-FC	1	3/8
R1-FD	1	1/2
R1-FE	1	3/4
R1-GC	1 1/4	3/8
R1-GD	1 1/4	1/2
R1-GE	1 1/4	3/4
R1-GF	1 1/4	1
R1-HD	1 1/2	1/2
R1-HE	1 1/2	3/4
R1-HF	1 1/2	1
R1-HG	1 1/2	1 1/4

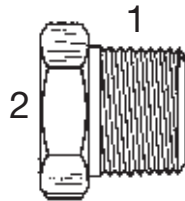

## HEX NIPPLES U10

PART NO.	PIPE THREAD
U10-A	1/8
U10-B	1/4
U10-C	3/8
U10-D	1/2
U10-E	3/4
U10-F	1

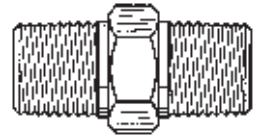

## HEX NIPPLES REDUCING U10

PART NO.	PIPE THREAD	PIPE THREAD
U10-BA	1/4	1/8
U10-CB	3/8	1/4
U10-DB	1/2	1/4
U10-DC	1/2	3/8
U10-ED	3/4	1/2

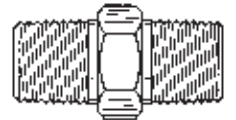

# BRASS PIPE FITTINGS

## 90° UNION ELBOW 100 – 100FL

PART NO.	PIPE THREAD
100-2-2*	1/8
100-2-2FL	1/8
100-4-4*	1/4
100-4-4FL	1/4
100-6-6*	3/8
100-6-6FL	3/8
100-8-8*	1/2
100-8-8FL	1/2
100-12-12*	3/4

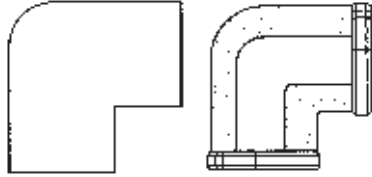

\*Forged

## 45° FEMALE ELBOW 100-45

PART NO.	PIPE THREAD
100-45-2	1/8
100-45-4	1/4
100-45-6	3/8
100-45-8	1/2
100-45-12	3/4

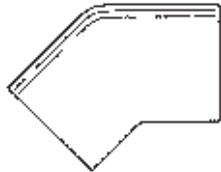

## UNION TEE 101 – 101FL

PART NO.	PIPE THREAD
101-2*	1/8
101-2FL	1/8
101-4*	1/4
101-4FL	1/4
101-6*	3/8
101-6FL	3/8
101-8*	1/2
101-8FL	1/2
101-12*	3/4
100-12-12FL	3/4

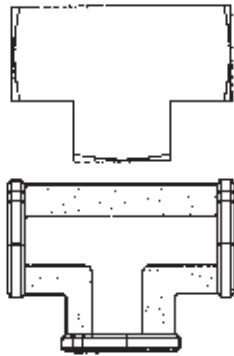

\*Forged

## CROSS 102

PART NO.	PIPE THREAD
102-2	1/8
102-4	1/4
102-6	3/8
102-8	1/2
102-12	3/4

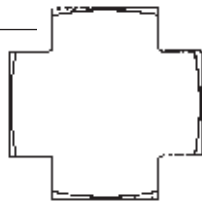

## COUPLING 103

PART NO.	PIPE THREAD
103-2	1/8
103-4	1/4
103-6	3/8
103-8	1/2
103-12	3/4

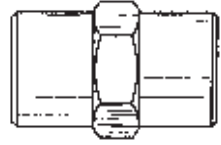

## UNION 104

PART NO.	PIPE THREAD
104-2	1/8
104-4	1/4
104-6	3/8
104-8	1/2
104-12	3/4

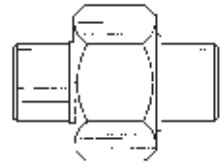

## CAP 108

PART NO.	PIPE THREAD
108-2	1/8
108-4	1/4
108-6	3/8
108-8	1/2
108-12	3/4
108-16	1



## SQUARE-HEAD PLUG 109

PART NO.	PIPE THREAD
109-2	1/8
109-4	1/4
109-6	3/8
109-8	1/2
109-12	3/4
109-16	1

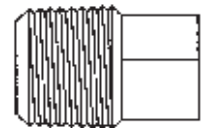

# BRASS PIPE FITTINGS

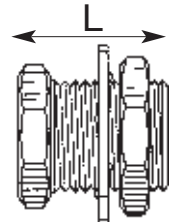

## BUSHING 110

PART NO.	MALE PIPE THREAD	FEMALE PIPE THREAD
110-4-2	1/4	1/8
110-6-2	3/8	1/8
110-6-4	3/8	1/4
110-8-2	1/2	1/8
110-8-4	1/2	1/4
110-8-6	1/2	3/8
110-12-2	3/4	1/8
110-12-4	3/4	1/4
110-12-6	3/4	3/8
110-12-8	3/4	1/2
110-16-4	1	1/4
110-16-6	1	3/8
110-16-8	1	1/2
110-16-12	1	3/4
110-18-6	1 1/4	3/8
110-18-8	1 1/4	1/2
110-18-12	1 1/4	3/4
110-18-16	1 1/4	1
110-20-8	1 1/2	1/2
110-20-12	1 1/2	3/4
110-20-16	1 1/2	1
110-20-18	1 1/2	1 1/4

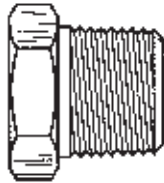

## ANCHOR COUPLING 68BH

PART NO.	FEMALE PIPE THREAD	STRAIGHT THREAD	L
68BH-2	1/8	5/8-18	1.50
68BH-2S	1/8	5/8-18	.96
68BH-4	1/4	3/4-16	1.50
68BH-4S	1/4	3/4-16	.94
68BH-6	3/8	1-14	1.31
68BH-8	1/2	1 1/8-14	1.50
68BH-12	3/4	1 5/16-12	1.50

## CLOSE NIPPLE 112

PART NO.	PIPE THREAD
112-2	1/8
112-4	1/4
112-6	3/8
112-8	1/2
112-12	3/4
112-16	1

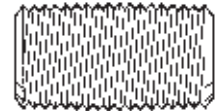

## FACE BUSHING 110FB

PART NO.	MPT	FPT
110FB-4-2	1/4	1/8
110FB-6-4	3/8	1/4
110FB-8-6	1/2	3/8
110FB-12-8	3/4	1/2



## LOCK NUT 111

PART NO.	PIPE THSREAD
111-2	1/8 NPSL
111-4	1/4 NPSL
111-6	3/8 NPSL
111-8	1/2 NPSL





# BRASS PIPE FITTINGS

## LONG NIPPLE 113

PART NO.	PIPE THREAD	LENGTH
113-2x1.5	1/8	1 1/2
113-4x1.5	1/4	1 1/2
113-6x1.5	3/8	1 1/2
113-8x1.5	1/2	1 1/2
113-12x1.5	3/4	1 1/2
113-2x2	1/8	2
113-4x2	1/4	2
113-6x2	3/8	2
113-8x2	1/2	2
113-12x2	3/4	2
113-1x2	1	2
113-2x2.5	1/8	2 1/2
113-4x2.5	1/4	2 1/2
113-6x2.5	3/8	2 1/2
113-8x2.5	1/2	2 1/2
113-12x2.5	3/4	2 1/2
113-1x2.5	1	2 1/2
113-2x3	1/8	3
113-4x3	1/4	3
113-6x3	3/8	3
113-8x3	1/2	3
113-12x3	3/4	3
113-1x3	1	3
113-2x3.5	1/8	3 1/2
113-4x3.5	1/4	3 1/2
113-6x3.5	3/8	3 1/2
113-8x3.5	1/2	3 1/2
113-12x3.5	3/4	3 1/2
113-1x3.5	1	3 1/2
113-2x4	1/8	4
113-4x4	1/4	4
113-6x4	3/8	4
113-8x4	1/2	4
113-12x4	3/4	4
113-1x4	1	4
113-2x4.5	1/8	4 1/2
113-4x4.5	1/4	4 1/2
113-6x4.5	3/8	4 1/2
113-8x4.5	1/2	4 1/2
113-12x4.5	3/4	4 1/2
113-1x4.5	1	4 1/2
113-2x5	1/8	5
113-4x5	1/4	5
113-6x5	3/8	5
113-8x5	1/2	5
113-12x5	3/4	5
113-1x5	1	5
113-2x5.5	1/8	5 1/2
113-4x5.5	1/4	5 1/2

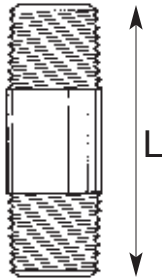

113-6x5.5	3/8	5 1/2
113-8x5.5	1/2	5 1/2
113-12x5.5	3/4	5 1/2
113-1x5.5	1	5 1/2
113-2x6	1/8	6
113-4x6	1/4	6
113-6x6	3/8	6
113-8x6	1/2	6
113-12x6	3/4	6
113-1x6	1	6

## 90° STREET ELBOW 116 – 116FL

PART NO.	1 PIPE THREAD	2 PIPE THREAD
116-2*	1/8	1/8
116-2FL	1/8	1/8
116-2-4	1/8	1/4
116-4-2	1/4	1/8
116-4*	1/4	1/4
116-4FL	1/4	1/4
116-4-6	1/4	1/8
116-6-4	3/8	1/4
116-6*	3/8	3/8
116-6FL	3/8	3/8
116-6-8	3/8	1/2
116-8-6	1/2	3/8
116-8*	1/2	1/2
116-8FL	1/2	1/2
116-12*	3/4	3/4
116-12FL	3/4	3/4

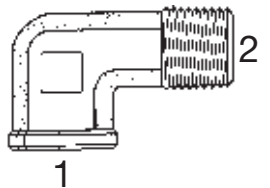
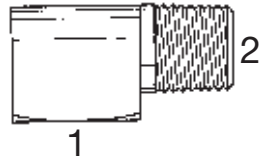

\*Forged

## MALE ELBOW 116M

PART NO.	PIPE THREAD
116M-2	1/8
116M-4	1/4
116M-6	3/8
116M-8	1/2

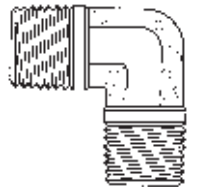

## SLOTTED-HEAD PLUG 117

PART NO.	PIPE THREAD
117-2	1/8
117-4	1/4
117-6	3/8



# BRASS PIPE FITTINGS

## COUNTERSUNK HEX-HEAD PLUG 118

PART NO.	PIPE THREAD
118-2	1/8
118-4	1/4
118-6	3/8
118-8	1/2
118-12	3/4

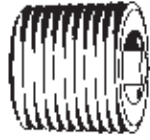

## HEX NIPPLE 122

PART NO.	PIPE THREAD
122-2	1/8
122-4	1/4
122-6	3/8
122-8	1/2
122-12	3/4
122-16	1

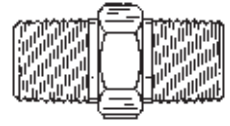

## REDUCER COUPLING 119

PART NO.	PIPE THREAD	PIPE THREAD
119-4-2	1/4	1/8
119-6-2	3/8	1/8
119-6-4	3/8	1/4
119-8-2	1/2	1/8
119-8-4	1/2	1/4
119-8-6	1/2	3/8
119-12-6	3/4	3/8
119-12-8	3/4	1/2



## HEX NIPPLE REDUCERS 123

PART NO.	PIPE THREAD	PIPE THREAD
123-4-2	1/4	1/8
123-6-2	3/8	1/8
123-6-4	3/8	1/4
123-8-4	1/2	1/4
123-8-6	1/2	3/8
123-12-8	3/4	1/2

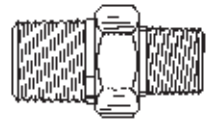

## ADAPTER 120

PART NO.	1 PIPE THREAD	2 PIPE THREAD
120-2-2	1/8	1/8
120-4-2	1/4	1/8
120-4-4	1/4	1/4
120-6-2	3/8	1/8
120-6-4	3/8	1/4
120-6-6	3/8	3/8
120-8-4	1/2	1/4
120-8-6	1/2	3/8
120-8-8	1/2	1/2
120-12-6	3/4	3/8
120-12-8	3/4	1/2
120-12-12	3/4	3/4

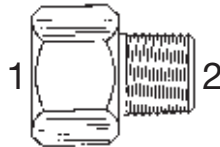

## 45° STREET ELBOW 124

PART NO.	PIPE THREAD
124-2	1/8
124-4	1/4
124-6	3/8
124-8	1/2
124-12	3/4

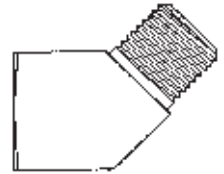

## MALE BRANCH TEE 3600

PART NO.	PIPE THREAD
3600-2	1/8
3600-4	1/4
3600-6	3/8
3600-8	1/2
3600-12	3/4

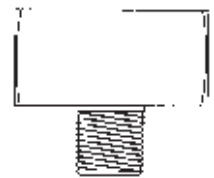

## HEX-HEAD PLUG 121

PART NO.	PIPE THREAD
121-2	1/8
121-4	1/4
121-6	3/8
121-8	1/2
121-12	3/4

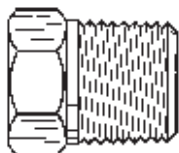

## STREET TEE 3750

PART NO.	PIPE THREAD
3750-2	1/8
3750-4	1/4
3750-6	3/8
3750-8	1/2
3750-12	3/4



# HOSE BARB FITTINGS

## HOSE BARB TO MALE PIPE 125

PART NO.	I.D. HOSE SIZE	PIPE THREAD
125-2-2	1/8	1/8
125-3-2	3/16	1/8
125-3-4	3/16	1/4
125-4-2	1/4	1/8
125-4-4	1/4	1/4
125-4-6	1/4	3/8
125-4-8	1/4	1/2
125-5-2	5/16	1/8
125-5-4	5/16	1/4
125-5-6	5/16	3/8
125-6-2	3/8	1/8
125-6-4	3/8	1/4
125-6-6	3/8	3/8
125-6-8	3/8	1/2
125-8-4	1/2	1/4
125-8-6	1/2	3/8
125-8-8	1/2	1/2
125-10-6	5/8	3/8
125-10-8	5/8	1/2
125-10-12	5/8	3/4
125-12-8	3/4	1/2
125-12-12	3/4	3/4
125-16-12	1	3/4
125-16-16	1	1

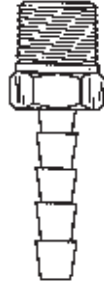

## BALL-END JOINT ADAPTER TO MALE PIPE 137HB

For use with 126S

PART NO.	MALE N.P.S.M. THREAD	MALE N.P.T. THREAD
137HB-4-2	1/4	1/8
137HB-4-4	1/4	1/4
137HB-6-4	3/8	1/4
137HB-6-6	3/8	3/8
137HB-8-6	1/2	3/8
137HB-8-8	1/2	1/2

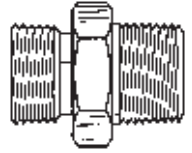

## HOSE BARB TO SWIVEL FEMALE BALL-END 126S

PART NO.	I.D. HOSE SIZE	FEMALE N.P.S.M. THREAD
126S-3-2	3/16	1/8
126S-4-2	1/4	1/8
126S-4-4	1/4	1/4
126S-5-4	5/16	1/4
126S-6-4	3/8	1/4
126S-6-6	3/8	3/8
126S-8-6	1/2	3/8
126S-8-8	1/2	1/2

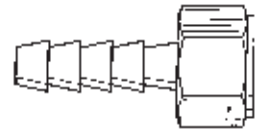

## HOSE BARB TO FEMALE PIPE 126

PART NO.	I.D. HOSE SIZE	PIPE THREAD
126-4-2	1/4	1/8
126-4-4	1/4	1/4
126-4-6	1/4	3/8
126-5-2	5/16	1/8
126-5-4	5/16	1/4
126-6-2	3/8	1/8
126-6-4	3/8	1/4
126-6-6	3/8	3/8
126-6-8	3/8	1/2
126-8-6	1/2	3/8
126-8-8	1/2	1/2
126-12-12	3/4	3/4

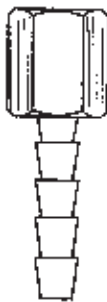

## HOSE BARB TO SWIVEL 45° FEMALE FLARE 146HB

PART NO.	I.D. HOSE SIZE	STRAIGHT THREAD
146HB-FSV-3-2	3/16	5/16-24
146HB-FSV-4-4	1/4	7/16-20
146HB-FSV-4-6	1/4	5/8-18
146HB-FSV-6-6	3/8	5/8-18

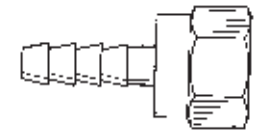

# HOSE BARB FITTINGS

## HOSE BARB 90° ELBOW TO MALE PIPE 129HB

PART NO.	I.D. HOSE SIZE	PIPE THREAD
129HB-3-2	3/16	1/8
129HB-4-2	1/4	1/8
129HB-4-4	1/4	1/4
129HB-4-6	1/4	3/8
129HB-5-2	5/16	1/8
129HB-5-4	5/16	1/4
129HB-5-6	5/16	3/8
129HB-6-2	3/8	1/8
129HB-6-4	3/8	1/4
129HB-6-6	3/8	3/8
129HB-6-8	3/8	1/2
129HB-8-4	1/2	1/4
129HB-8-6	1/2	3/8
129HB-8-8	1/2	1/2
129HB-10-6	5/8	3/8
129HB-10-8	5/8	1/2
129HB-12-12	3/4	3/4

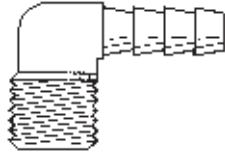

## HOSE BARB 45° ELBOW TO MALE PIPE 136HB

PART NO.	I.D. HOSE SIZE	PIPE THREAD
136HB-4-2	1/4	1/8
136HB-4-4	1/4	1/4
136HB-5-2	5/16	1/8
136HB-5-4	5/16	1/4
136HB-6-2	3/8	1/8
136HB-6-4	3/8	1/4
136HB-6-6	3/8	3/8
136HB-6-8	3/8	1/2

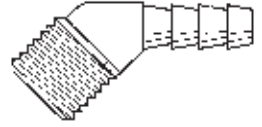

## HOSE MENDER HM138

PART NO.	I.D. HOSE SIZE
HM138-3	3/16
HM138-4	1/4
HM138-5	5/16
HM138-6	3/8
HM138-8	1/2
HM138-12	3/4



# GARDEN HOSE FITTINGS

## HOSE BARB TO MALE HOSE THREAD 201GH

PART NO.	I.D. HOSE SIZE	HOSE THREAD
201GH-8	1/2	3/4
201GH-10	5/8	3/4
201GH-12	3/4	3/4

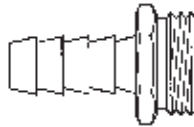

## SWIVEL CONNECTOR HOSE BARB TO FEMALE GARDEN HOSE 209GHS

PART NO.	I.D. HOSE SIZE	HOSE THREAD
209GHS-4	1/4	3/4
209GHS-6	3/8	3/3
209GHS-8	1/2	3/4
209GHS-10	5/8	3/4
209GHS-12	3/4	3/4

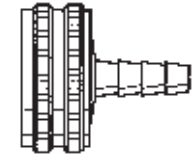

## COMPLETE HOSE MENDER 202GHS

PART NO.	I.D. HOSE SIZE
202GHS-8	1/2
202GHS-10	5/8
202GHS-12	3/4

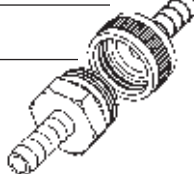

## MALE HOSE TO MALE HOSE 127

PART NO.	HOSE THREAD
127	3/4



## FEMALE HOSE TO FEMALE PIPE 128

PART NO.	HOSE THREAD	PIPE THREAD
128-12-8	3/4	1/2
128-12-12	3/4	3/4

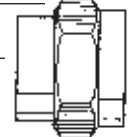

## MALE HOSE TO MALE PIPE 129

PART NO.	HOSE THREAD	PIPE THREAD	FEMALE PIPE THREAD	"SWEAT" I.D.
129-12-4	3/4	1/4		
129-12-6	3/4	3/8		
129-12-8	3/4	1/2		
129-12-8-8	3/4	1/2		1/2
129-12-12	3/4	3/4		
129-12-12-8	3/4	3/4	1/2	

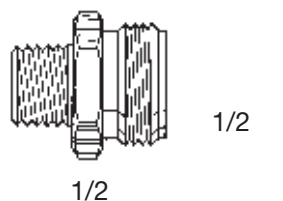

## FEMALE HOSE TO MALE PIPE 130

PART NO.	HOSE THREAD	PIPE THREAD
130-12-8	3/4	1/2
130-12-12	3/4	3/4

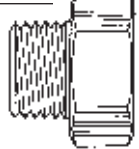

## MALE HOSE TO FEMALE PIPE 131

PART NO.	HOSE THREAD	PIPE THREAD
131-12-4	3/4	1/4
131-12-6	3/4	3/8
131-12-8	3/4	1/2
130-12-12	3/4	3/4

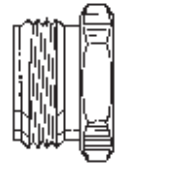

## FEMALE HOSE TO FEMALE HOSE SOLID 132

PART NO.	HOSE THREAD
132	3/4

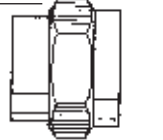

## KNURLED HOSE CAP 140

PART NO.	HOSE THREAD
140-B Brass	3/4
140-C Die Cast	3/4



## HOSE NUT REDUCER 140-12

PART NO.	HOSE THREAD	PIPE THREAD
140-12-2	3/4	1/8
140-12-4	3/4	1/4



## KNURLED HOSE NUT 141

PART NO.	HOSE THREAD
141	3/4



## GARDEN HOSE "Y" DIE CAST 142

PART NO.	HOSE THREAD
142	3/4



# GARDEN HOSE FITTINGS

## GARDEN HOSE CAP WITH CHAIN – DIE CAST 143

12" chain

PART NO.	HOSE THREAD
143	3/4



## SWIVEL CONNECTOR FEMALE HOSE TO FEMALE HOSE 132S

PART NO.	HOSE THREAD
132S	3/4

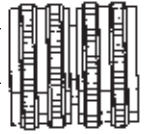

## SWIVEL CONNECTOR FEMALE GARDEN HOSE TO MALE PIPE 138

PART NO.	HOSE THREAD	PIPE THREAD
138-12-4	3/4	1/4
138-12-6	3/4	3/8

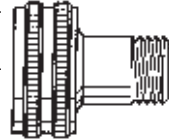

## GARDEN HOSE COUPLING WASHER GHW

PART NO.	HOSE NO.	THREAD
GHW	3/4	



NOTE: All female connector ends should have this rubber washer installed prior to usage.

## SWIVEL CONNECTOR FEMALE HOSE TO FEMALE PIPE 128S

PART NO.	HOSE THREAD	PIPE THREAD
128S-8	3/4	1/2
128S-12	3/4	3/4



# FORGED BRASS PEX FITTINGS



## ELBOWS

PART NO.	DESCRIPTION	AVAILABLE IN BAGS OF
PXL02	3/8" PEX Barb Elbow	25
PXL03	1/2" PEX Barb Elbow	50
PXL058	5/8" PEX Barb Elbow	25
PXL04	3/4" PEX Barb Elbow	25
PXL05	1" PEX Barb Elbow	15
PXLM0303	1/2" PEX Barb X 1/2" IP Male Elbow	50
PXLM0304	1/2" PEX Barb X 3/4" IP Male Elbow	25
PXLM0404	3/4" PEX Barb X 3/4" IP Male Elbow	25
PXRL0403	3/4" PEX Barb X 1/2" PEX Barb Red. Elbow	25
PXLD0303	1/2" PEX Barb X 1/2" FIP Drop Ear Elbow	50



## TEES

PART NO.	DESCRIPTION	AVAILABLE IN BAGS OF
PXT02	3/8" PEX Barb Tee	50
PXT03	1/2" PEX Barb Tee	50
PXT58	5/8" PEX Barb Tee	25
PXT04	3/4" PEX Barb Tee	25
PXT05	1" PEX Barb Tee	15
PXRT030304	1/2" Barb X 1/2" Barb X 3/4" Barb PEX Red. Tee	25
PXRT040303	3/4" Barb X 1/2" Barb X 1/2" Barb PEX Red. Tee	25
PXRT040304	3/4" Barb X 1/2" Barb X 3/4" Barb PEX Red. Tee	25
PXRT040403	3/4" Barb X 3/4" Barb X 1/2" Barb PEX Red. Tee	25
PXRT040405	3/4" Barb X 3/4" Barb X 1" Barb Red. Tee	15
PXRT050404	1" Barb X 3/4" Barb X 3/4" Barb Red. Tee	15
PXRT050503	1" Barb X 1" Barb X 1/2" Barb Red. Tee	15
PXRT050504	1" Barb X 1" Barb X 3/4" Barb Red. Tee	15



## COUPLINGS

PART NO.	DESCRIPTION	AVAILABLE IN BAGS OF
PXCP02	3/8" PEX Barb Coupling	25
PXCP03	1/2" PEX Barb Coupling	50
PXCP58	5/8" PEX Barb Coupling	25
PXCP04	3/4" PEX Barb Coupling	25
PXCP05	1" PEX Barb Coupling	15
PXCPR0302	1/2" X 3/8" PEX Barb Red. Coupling	50
PXCPR0403	3/4" X 1/2" PEX Barb Red. Coupling	25
PXCPR0504	1" X 3/4" PEX Barb Red. Coupling	15



## PLUGS

PART NO.	DESCRIPTION	AVAILABLE IN BAGS OF
PXPL02	3/8" PEX End Plug	25
PXPL03	1/2" Barb End Plug	50
PXPL04	3/4" Barb End Plug	25
PXPL05	1" Barb End Plug	15

# FORGED BRASS PEX FITTINGS



## ADAPTERS

PART NO.	DESCRIPTION	AVAILABLE IN BAGS OF
PXMA0303	1/2" PEX Barb X	
	1/2" IP Male Adapter	50
PXMA0304	1/2" PEX Barb X	
	3/4" IP Male Adapter	25
PXMA0403	3/4" PEX Barb X	
	1/2" IP Male Adapter	25
PXMA0404	3/4" PEX Barb X	
	3/4" IP Male Adapter	25
PXMA0405	3/4" PEX Barb X	
	1" IP Male Adapter	15
PXMA0504	1" PEX Barb X	
	3/4" IP Male Adapter	15
PXMA0505	1" PEX Barb X	
	1" IP Male Adapter	15
PXMAS0303	1/2" Male Sweat X	
	1/2" PEX Barb Adapter	50
PXMAS0404	3/4" Male Sweat X	
	3/4" PEX Barb Adapter	25
PXMAS0505	1" Male Sweat X	
	1" PEX Barb Adapter	15
PXFAC0303	1/2" Sweat X	
	1/2" PEX Barb Adapter	50
PXFAC0404	3/4" Sweat X	
	3/4" PEX Barb Adapter	25
PXFAC0505	1" Sweat X	
	1" PEX Barb Adapter	15
PXFA0303	1/2" PEX Barb X	
	1/2" IP Female Adapter	50
PXFA0304	1/2" PEX Barb X	
	3/4" IP Female Adapter	35
PXFA0404	3/4" PEX Barb X	
	3/4" IP Female Adapter	25



## COPPER CRIMP RINGS

PART NO.	DESCRIPTION	AVAILABLE IN BAGS OF
PXCR03	1/2" Crimp Ring	100
PXCR04	3/4" Crimp Ring	100
PXCR05	1" Crimp Ring	100



## COMPRESSION COUPLINGS

PART NO.	DESCRIPTION	AVAILABLE IN BAGS OF
450PX03	1/2" PEX X 1/2" PEX Brass Compression Coupling	10
450PXC03	1/2" PEX X 1/2" CXC Brass Compression Coupling	10
450PXC0304	1/2" PEX X 3/4" CXC Brass Compression Coupling	10
450PXCMP0304	5/8" PEX X 3/4" CXC Brass Compression Coupling	10
450PXCM03	1/2" PEX X 1/2" MCXC Brass Compression Coupling	10
450PXF03	1/2" PEX X 1/2" FIP Brass Compression Coupling	10
450PXM03	1/2" PEX X 1/2" MIP Brass Compression Coupling	10
450PXM04	3/4" PEX X 3/4" MIP Brass Compression Coupling	10



# MISCELLANEOUS

## AIR VALVE COMBINATION COIN/KEY 313

PART NO.	MIP	FINISH
313	1/8	Nickel Plated



## AIR VALVE KEY 314

PART NO.	MIP	FINISH
314	1/8	Nickel Plated

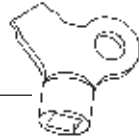

## DUPLEX BUSHINGS WITH FITTINGS 415

PART NO.	
415-6	2 x 3/8 OD
415-8	2 x 1/2 OD



## ALUMINUM TUBING AL

50-foot coil

PART NO.	O.D.
AL-2	1/8
AL-3	3/16
AL-4	1/4
AL-5	5/16
AL-6	3/8
AL-7	7/16
AL-8	1/2



## CAP ORIFICE 272

PART NO.	STRAIGHT THREAD	DRILL
272-72	3/8-27	#72
272-80	3/8-27	#80



# GAS STOVE ADAPTERS

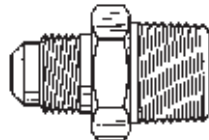

## GAS APPLIANCE ADAPTER TO MPT 48GA

PART NO.	PIPE THREAD	STRAIGHT THREAD
48GA-8	1/2	15/16
48GA-12	3/4	15/16

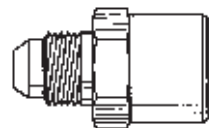

## GAS APPLIANCE ADAPTER TO FPT 46GA

PART NO.	PIPE THREAD	STRAIGHT THREAD
46GA-8	1/2	15/16
46GA-12	3/4	15/16

Gas appliance fittings are designed to be used with the new AGA standards pertaining to flexible connectors and adapt to standard size threads.

## CONTROL NUT 81LB

PART NO.	TUBE SIZE
81LB-	1/8
81LB-	3/16
81LB-	1/4
81LB-	3/8

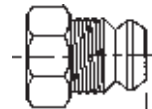

# POL FITTINGS

## POL CAP 2004

PART NO.	SIZE
2004	.880-14 LH Thread



## POL NUT 2001

PART NO.	SIZE
2001	7/8 Hex

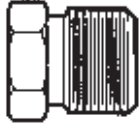

## POL NUT 2002

PART NO.	SIZE
2002	1 1/8 Hex



## POL PLUG 2014

PART NO.	SIZE
2014	.880-14 LH Thread

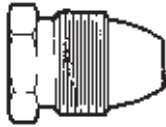

## POL CHECK TEE 2015

PART NO.	PIPE THREAD	INTERNAL THREAD
2015	1/4-18 NPTF	7/16-24 UNS

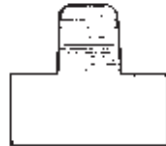

## POL ADAPTER 2000

2 9/16" long with Wrench Flats

PART NO.
2000



## POL TO FLARE

.880-14 LH to SAE

PART NO.	SIZE	STRAIGHT THREAD
2005	POL x 3/8	5/8-18
2006	POL x 1/2	3/4-16
2007	POL x 5/8	7/8-14



## POL ADAPTER 2000A

2 9/16" long with Hex Nose

PART NO.
2000A

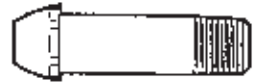

# BRASS LAVATORY SUPPLIES

## BRASS LAVATORY NOSEPIECE 317

PART NO.	O.D.
317	3/8



## BASINCOCK TAILPIECE

PART NO.	MIP	LENGTH
306	1/4	1 1/2
307	1/4	2
308	1/4	3



## BRASS BALLCOCK COUPLING NUT 302

PART NO.	DESCRIPTION
302	Standard for Tailpiece



## BRASS BASINCOCK COUPLING NUT 305

PART NO.	DESCRIPTION
305	Standard for Tailpiece

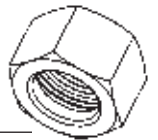

## BRASS OVERFLOW TUBE CONVERTER 330

PART NO.	DESCRIPTION
330-A	Small 1 1/8-27
330-B	Large 1 1/4-27
330-C	Inside 1-27

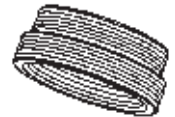

## BRASS TRAP CLEANOUT PLUG 190

PART NO.	MALE THREAD	FINISH
190-16-RB	1	Rough Brass



# NEEDLE VALVES

## NEEDLE VALVE 77

Compression to Compression  
\*Provided with pin handle

PART NO.	TUBE SIZE
77-4*	1/4
77-6	3/8
77CA-4*	1/4
77CA-6	3/8

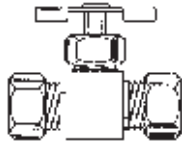

## NEEDLE VALVE 78

Compression to Male Pipe

PART NO.	TUBE SIZE	PIPE THREAD
78-4-2*	1/4	1/8
78-4-4*	1/4	1/4
78-5-2*	5/16	1/8
78-6-4	3/8	1/4

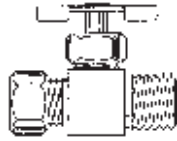

## ANGLE NEEDLE VALVE 79

Compression to Male Pipe

PART NO.	TUBE SIZE	PIPE THREAD
79-4-2	1/4	1/8
79CA-4-2	1/4	1/8
79-4-4	1/4	1/4
79-5-2	5/16	1/8
79-6-4	3/8	1/4

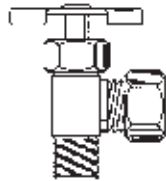

## NEEDLE VALVE 229

Flare to Male Pipe  
\*Provided with pin handle

PART NO.	TUBE SIZE	PIPE THREAD
229-4-2*	1/4	1/8
229-6-4	3/8	1/4

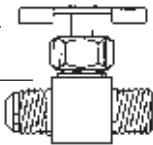

## NEEDLE VALVE 230

Flare to Flare  
\*Provided with pin handle

PART NO.	TUBE SIZE
230-4*	1/4
230-6	3/8

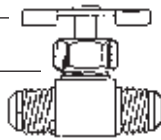

## ANGLE NEEDLE VALVE 249

Flare to Male Pipe

PART NO.	TUBE SIZE	PIPE THREAD
249-4-2	1/4	1/8
249-6-4	3/8	1/4

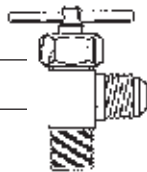

## SELF-PIERCING HUMIDIFIER VALVE CLAMP KIT 75

PART NO.	TUBE SIZE	PIPE THREAD
75	1/4	1/8

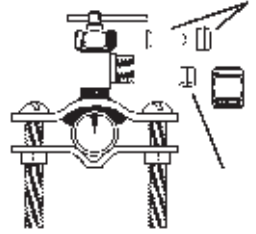

## NEEDLE VALVE 284

Female Pipe to Female Pipe  
\*Provided with pin handle

PART NO.	PIPE THREAD
284-2*	1/8
284-4	1/4

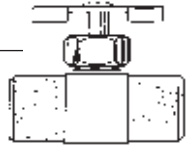

## NEEDLE VALVE 285

Female Pipe to Male Pipe  
\*Provided with pin handle

PART NO.	PIPE THREAD
285-2*	1/8
285-4	1/4

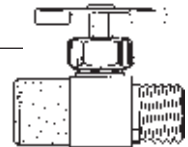

## NEEDLE VALVE 286

Male Pipe to Male Pipe  
\*Provided with pin handle

PART NO.	PIPE THREAD	H	L	M
286-2*	1/8	1.50	1.35	1.25
286-4	1/4	1.38	1.54	1.65

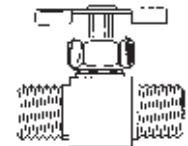

## ICE MAKER KITS

### ICE MAKER KIT

Self Tapping

PART NO.	MATERIAL
175	Polyethylene Tubing
275	Copper Tubing

### COLD WATER HOOK-UP KITS FOR HUMIDIFIERS & REFRIGERATORS

Handy kit includes:

- 75 valve
- 25 feet of tubing
- Connections to fit popular refrigerator ice-maker inlets
- Necessary adapters, sleeves, nuts, inserts, etc.

# DRAINCOCKS/GROUND PLUG SHUT-OFFS

## GROUND PLUG SHUTOFF 82

PART NO.	PIPE THREAD
----------	-------------

82-2	1/8
82-4	1/4
82-6	3/8
82-8	1/2

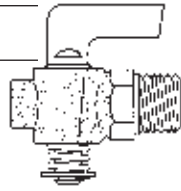

## GROUND PLUG SHUTOFF 31

*Female Pipe to Female Pipe*

PART NO.	FEMALE PIPE THREAD
----------	--------------------

31-2	1/8
31-4	1/4
31-6	3/8

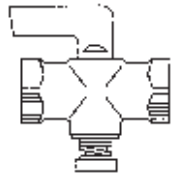

## OIL TANK VALVE 36

*Flare to MPT*

PART NO.	TUBE SIZE	PIPE THREAD
----------	-----------	-------------

36-68	3/8	1/2
36-612	3/8	3/4
36-812	1/2	3/4



## GROUND PLUG SHUTOFF 32

*Female Pipe to Male Pipe*

PART NO.	PIPE THREAD
----------	-------------

32-2	1/8
32-4	1/4
32-6	3/8

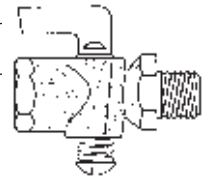

## GROUND PLUG SHUTOFF 80

*Compression to Male Pipe*

PART NO.	TUBE SIZE	PIPE THREAD
----------	-----------	-------------

80-4-2	1/4	1/8
80-CA-4-2	1/4	1/8
80-4-4	1/4	1/4
80-CA-4-4	1/4	1/4
80-6-4	3/8	1/4
80-CA-6-4	3/8	1/4

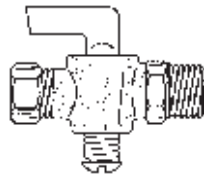

## GROUND PLUG SHUTOFF 33

*Male Pipe to Male Pipe*

PART NO.	PIPE THREAD
----------	-------------

33-2	1/8
33-4	1/4

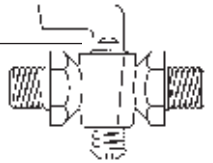

## GROUND PLUG SHUTOFF 81

*Compression to Compression*

PART NO.	TUBE SIZE
----------	-----------

81-4	1/4
81-CA-4	1/4
80-6	3/8

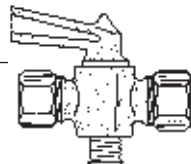

## EXTERNAL SEAL DRAINCOCK 85

*Male Pipe to Male Pipe*

PART NO.	PIPE THREAD
----------	-------------

85-2	1/8
85-4	1/4
85-6	3/8
85-8	1/2



## GROUND PLUG SHUTOFF 29

*Flare to Male Pipe*

PART NO.	TUBE SIZE	PIPE THREAD
----------	-----------	-------------

29-4-2	1/4	1/8
29-6-4	3/8	1/4

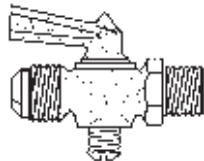

## DRAINCOCK HEAVY PATTERN 85H

PART NO.	PIPE THREAD
----------	-------------

85H-2	1/8
85H-4	1/4
85H-6	3/8

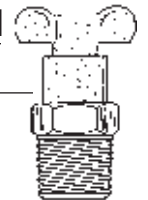

## GROUND PLUG SHUTOFF 30

*Flare to Flare*

PART NO.	TUBE SIZE
----------	-----------

30-6-6	3/8
30-8-8	1/2

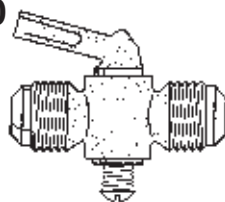

## BIB DRAIN VALVE 150

PART NO.	HOSE SIZE	PIPE THREAD
----------	-----------	-------------

150-1	3/8	1/4
150-2	1/4	1/8

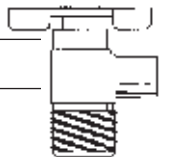

# 125-LB. THREADED BRASS FITTINGS

## COUPLINGS R103

PART NO.	SIZE
R1032	1/8
R1034	1/4
R1036	3/8
R1038	1/2
R10312	3/4
R10316	1
R10318	1 1/4
R10320	1 1/2
R10322	2
R10324	2 1/2
R10326	3
R10328	4



## REDUCING COUPLINGS R119

PART NO.	SIZE
<b>1/4", 3/8", 1/2"</b>	
R11942	1/4 x 1/8
R11964	3/8 x 1/4
R11962	3/8 x 1/8
R11986	1/2 x 3/8
R11984	1/2 x 1/4
R11982	1/2 x 1/8
<b>3/4"</b>	
R119128	3/4 x 1/2
R119126	3/4 x 3/8
R119124	3/4 x 1/4
<b>1"</b>	
R1191612	1 x 3/4
R119168	1 x 1/2
R119166	1 x 3/8
R119164	1 x 1/4
<b>1 1/4"</b>	
R1191816	1 1/4 x 1
R1191812	1 1/4 x 3/4
R119188	1 1/4 x 1/2
<b>1 1/2"</b>	
R1192018	1 1/2 x 1 1/4
R1192016	1 1/2 x 1
R1192012	1 1/2 x 3/4
R119208	1 1/2 x 1/2
<b>2"</b>	
R1192220	2 x 1 1/2
R1192218	2 x 1 1/4
R1192216	2 x 1
R1192212	2 x 3/4
R119228	2 x 1/2
<b>2 1/2"</b>	
R1192422	2 1/2 x 2
<b>3"</b>	
R1192624	3 x 2 1/2
R1192622	3 x 2
<b>4"</b>	
R1192822	4 x 2



## HEXAGON BUSHINGS R110

PART NO.	SIZE
<b>1/4", 3/8", 1/2"</b>	
R11042	1/4 x 1/8
R11064	3/8 x 1/4
R11062	3/8 x 1/8
R11086	1/2 x 3/8
R11084	1/2 x 1/4
R11082	1/2 x 1/8
<b>3/4"</b>	
R110128	3/4 x 1/2
R110126	3/4 x 3/8
R110124	3/4 x 1/4
R110122	3/4 x 1/8
<b>1"</b>	
R1101612	1 x 3/4
R110168	1 x 1/2
R110166	1 x 3/8
R110164	1 x 1/4
<b>1 1/4"</b>	
R1101816	1 1/4 x 1
R1101812	1 1/4 x 3/4
R110188	1 1/4 x 1/2
R110186	1 1/4 x 3/8
R110184	1 1/4 x 1/4
<b>1 1/2"</b>	
R1102018	1 1/2 x 1 1/4
R1102016	1 1/2 x 1
R1102012	1 1/2 x 3/4
R110208	1 1/2 x 1/2
R110206	1 1/2 x 3/8
R110204	1 1/2 x 1/4
<b>2"</b>	
R1102220	2 x 1 1/2
R1102218	2 x 1 1/4
R1102216	2 x 1
R1102212	2 x 3/4
R110228	2 x 1/2
R110226	2 x 3/8
<b>2 1/2"</b>	
R1102422	2 1/2 x 2
R1102420	2 1/2 x 1 1/2
R1102418	2 1/2 x 1 1/4
R1102416	2 1/2 x 1
R1102412	2 1/2 x 3/4
<b>3"</b>	
R1102624	3 x 2 1/2
R1102622	3 x 2
R1102620	3 x 1 1/2
<b>4"</b>	
R1102826	4 x 3
R1102824	4 x 2 1/2
R1102822	4 x 2

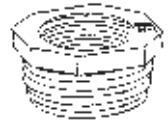

# 125-LB. THREADED BRASS FITTINGS

## UNIONS R104

PART NO.	SIZE
R1042	1/8
R1044	1/4
R1046	3/8
R1048	1/2
R10412	3/4
R10416	1
R10418	1 1/4
R10420	1 1/2
R10422	2
R10424	2 1/2
R10426	3
R10428	4

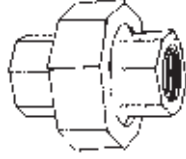

## 45° ELBOWS R10045

PART NO.	SIZE
R100452	1/8
R100454	1/4
R100456	3/8
R100458	1/2
R1004512	3/4
R1004516	1
R1004518	1 1/4
R1004520	1 1/2
R1004522	2
R1004524	2 1/2
R1004526	3
R1004528	4

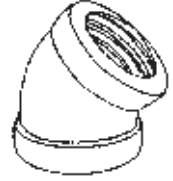

## 90° ELBOWS R100

PART NO.	SIZE
R1002	1/8
R1004	1/4
R1006	3/8
R1008	1/2
R10012	3/4
R10016	1
R10018	1 1/4
R10020	1 1/2
R10022	2
R10024	2 1/2
R10026	3
R10028	4

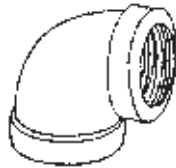

### 90° Reducing Elbows:

PART NO.	SIZE
R10042	1/4 x 1/8
R10064	3/8 x 1/4
R10062	3/8 x 1/8
R10086	1/2 x 3/8
R10084	1/2 x 1/4
R10082	1/2 x 1/8
R100128	3/4 x 1/2
R100126	3/4 x 3/8
R1001612	1 x 3/4
R100168	1 x 1/2

Additional reducing sizes available upon request

## 45° STREET ELBOWS R124

PART NO.	SIZE
R1242	1/8
R1244	1/4
R1246	3/8
R1248	1/2
R12412	3/4
R12416	1
R12418	1 1/4
R12420	1 1/2
R12422	2

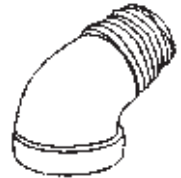

## 90° STREET ELBOWS R116

PART NO.	SIZE
R1162	1/8
R1164	1/4
R1166	3/8
R1168	1/2
R11612	3/4
R11616	1
R11618	1 1/4
R11620	1 1/2
R11622	2
R11624	2.5
R11626	3

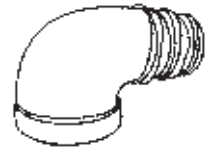

# 125-LB. THREADED BRASS FITTINGS

## TEES R101

PART NO.	SIZE
R1012	1/8
R1014	1/4
R1016	3/8
R1018	1/2
R10112	3/4
R10116	1
R10118	1 1/4
R10120	1 1/2
R10122	2
R10124	2 1/2
R10126	3
R10128	4

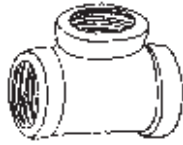

*Reducing Tees available upon request*

## CAP R108

PART NO.	SIZE
R1082	1/8
R1084	1/4
R1086	3/8
R1088	1/2
R10812	3/4
R10816	1
R10818	1 1/4
R10820	1 1/2
R10822	2
R10824	2 1/2
R10826	3
R10828	4

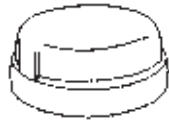

## SQUARE HEAD PLUGS R109

PART NO.	SIZE
R1092	1/8
R1094	1/4
R1096	3/8
R1098	1/2
R10912	3/4
R10916	1
R10918	1 1/4
R10920	1 1/2
R10922	2
R10924	2 1/2
R10926	3
R10928	4



## SQUARE SOLID PLUGS R109S

PART NO.	SIZE
R109S8	1/2
R109S12	3/4
R109S16	1
R109S18	1 1/4
R109S20	1 1/2
R109S22	2



## HEXAGON LOCKNUTS R111

PART NO.	SIZE
R1114	1/4
R1116	3/8
R1118	1/2
R11112	3/4
R11116	1
R11118	1 1/4
R11120	1 1/2
R11122	2



## CROSSES R102

PART NO.	SIZE
R1024	1/4
R1026	3/8
R1028	1/2
R10212	3/4
R10216	1
R10218	1 1/4
R10220	1 1/2
R10222	2

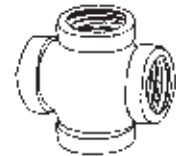

# Decimal and Millimeter Equivalents of Fractions

FRACTION	INCHES	M/M
$\frac{1}{64}$	.01563	.397
$\frac{1}{32}$	.03125	.794
$\frac{3}{64}$	.04688	1.191
$\frac{1}{16}$	.06250	1.588
$\frac{5}{64}$	.07813	1.984
$\frac{3}{32}$	.09375	2.381
$\frac{7}{64}$	.10938	2.778
$\frac{1}{8}$	.12500	3.175
$\frac{9}{64}$	.14063	3.572
$\frac{5}{32}$	.15625	3.969
$\frac{11}{64}$	.17188	4.366
$\frac{3}{16}$	.18750	4.763
$\frac{13}{64}$	.20313	5.159
$\frac{7}{32}$	.21875	5.556
$\frac{15}{64}$	.23438	5.953
$\frac{1}{4}$	.25000	6.350
$\frac{17}{64}$	.26563	6.747
$\frac{9}{32}$	.28125	7.144
$\frac{19}{64}$	.29688	7.541
$\frac{5}{16}$	.31250	7.938
$\frac{21}{64}$	.32813	8.334
$\frac{11}{32}$	.34375	8.731
$\frac{23}{64}$	.35938	9.128
$\frac{3}{8}$	.37500	9.525
$\frac{25}{64}$	.39063	9.922
$\frac{13}{32}$	.40625	10.319
$\frac{27}{64}$	.42188	10.716
$\frac{7}{16}$	.43750	11.113
$\frac{29}{64}$	.45313	11.509
$\frac{15}{32}$	.46875	11.906
$\frac{31}{64}$	.48438	12.303
$\frac{1}{2}$	.50000	12.700

FRACTION	INCHES	M/M
$\frac{33}{64}$	.51563	13.097
$\frac{17}{32}$	.53125	13.494
$\frac{35}{64}$	.54688	13.891
$\frac{9}{16}$	.56250	14.288
$\frac{37}{64}$	.57813	14.684
$\frac{19}{32}$	.59375	15.081
$\frac{39}{64}$	.60938	15.478
$\frac{5}{8}$	.62500	15.875
$\frac{41}{64}$	.64063	16.272
$\frac{21}{32}$	.65625	16.669
$\frac{43}{64}$	.67188	17.066
$\frac{11}{16}$	.68750	17.463
$\frac{45}{64}$	.70313	17.859
$\frac{23}{32}$	.71875	18.256
$\frac{47}{64}$	.73438	18.653
$\frac{3}{4}$	.75000	19.050
$\frac{49}{64}$	.76563	19.447
$\frac{25}{32}$	.78125	19.844
$\frac{51}{64}$	.79688	20.241
$\frac{13}{16}$	.81250	20.638
$\frac{53}{64}$	.82813	21.034
$\frac{27}{32}$	.84375	21.431
$\frac{55}{64}$	.85938	21.828
$\frac{7}{8}$	.87500	22.225
$\frac{57}{64}$	.89063	22.622
$\frac{29}{32}$	.90625	23.019
$\frac{59}{64}$	.92188	23.416
$\frac{15}{16}$	.93750	23.813
$\frac{61}{64}$	.95313	24.209
$\frac{31}{32}$	.96875	24.606
$\frac{63}{64}$	.98438	25.003
<b>1</b>	<b>1.00000</b>	<b>25.400</b>

## 45° Flare Nose Cone Sizes



## Male Pipe Thread Profiles





# BRASS FITTINGS

Compression, Flare and Pipe

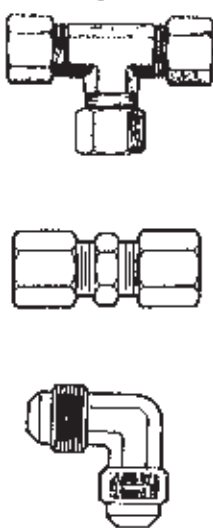

COMPRESSION FITTINGS  
45° FLARE  
BRASS PIPE FITTINGS  
BRASS NIPPLES  
INVERTED FLARE TUBE FITTINGS  
THREADED SLEEVE  
HOSE BARBS  
GARDEN HOSE FITTINGS  
NEEDLE VALVES  
DRAIN COCKS & VALVES  
GAS STOVE ADAPTERS  
CHROME PLATES FITTINGS



*Complete Line Available  
For Fast Delivery From Stock*



**GRUNER BRASS FITTINGS CORP.**

173 Glenmore Avenue, Brooklyn, NY 11212

Tel. (718) 495-5820 • Fax (718) 495-5824

info@grunerbrass.com • www.grunerbrass.com